

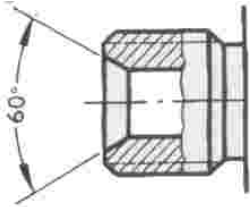
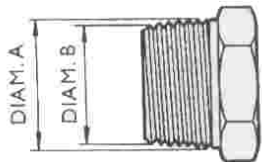
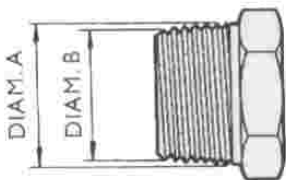

Diámetro de Roscas

BSP (GAS)	Rosca	Ø interior H.	Ø exterior M.
La rosca M. lleva un cono H. a 60° La rosca H. lleva un cono M. a 60° 	1/8-28	8.70	9.72
	1/4-19	11.70	13.20
	3/8-19	18.15	16.70
	1/2-14	18.90	21.00
	5/8-14	20.90	22.90
	3/4-14	24.30	26.40
	1"-11	30.60	33.24
	1"1/4-11	39.30	41.90
	1"1/2-11	45.15	47.80
	2"11	57.00	59.60

BSPT	Rosca	A	B
Rosca cónica 	1/8-28	10.20	9.48
	1/4-19	13.90	12.85
	3/8-19	17.30	16.26
	1/2-14	21.90	20.55
	3/4-14	27.30	25.84
	1"-11	34.40	32.65
	1"1/4-11	42.90	41.11
	1"1/2-11	48.80	47.08
	2"11	60.94	58.62

NPTF	Rosca	A	B
Rosca cónica 	1/8-27	10.59	9.98
	1/4-18	14.12	13.28
	3/8-18	17.55	16.71
	1/2-14	21.84	21.08
	3/4-14	27.17	26.13
	1-11.5	33.96	32.74
	1"1/4-11.5	42.72	41.47
	1"1/2-11.5	48.81	47.65
	2"11.5	60.88	59.56

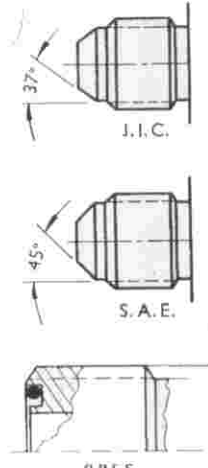
J.I.C. (SAE)-ORFS	Rosca	Ø interior H.	Ø exterior M.
J.I.C. cierre a 37°. SAE cierre a 45°. ORFS cierre junta plana. 	3/8-24 J.I.C./SAE	8.73	9.52
	7/16-20 J.I.C./SAE	9.92	11.11
	1/2-20 J.I.C./SAE	11.11	12.70
	9/16-18 J.I.C./ORFS	12.70	14.28
	5/8-18 SAE	14.70	15.85
	11/16-16 ORFS	15.40	17.40
	3/4-16 J.I.C./SAE	17.46	19.05
	13/16-16 ORFS	18.60	20.05
	7/8-14 J.I.C./SAE	20.63	22.17
	1"-14 ORFS	23.10	25.30
	1"1/16-12 J.I.C.	24.60	26.95
	1"1/16-14 SAE	24.60	26.95
	1"3/16-12 ORFS	27.50	30.10
	1"5/16-12 J.I.C.	30.95	30.33
	1"5/16-14 SAE	30.95	30.33
	1"7/16-12 ORFS	33.80	36.40
	1"5/8-12 J.I.C.	38.89	41.27
	1"5/8-14 SAE	38.89	41.27
	1"11/16-12 ORFS	40.48	42.80
	1"7/8-12 J.I.C.	45.24	47.62
	1"7/8-14 SAE	45.24	47.62
	2"-12 ORFS	48.40	50.80
	2"1/2-12 J.I.C./SAE	61.11	63.50

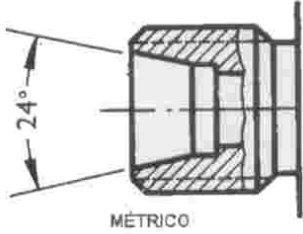

Métrico	Rosca	∅ interior H.	∅ exterior M.	∅ Tubo
Rosca métrica cono 24° 	12-150	10.05	12	6L
	14-150	12.05	14	6S/8L
	16-150	14.05	16	8S/10L
	18-150	16.05	18	10S/12L
	20-150	18.05	20	12S
	22-150	20.05	22	14S/15L
	24-150	22.05	24	16S
	26-150	24.05	26	18L
	30-200	27.40	30	20S/22L
	36-200	33.40	36	25S/28L
	42-200	39.40	42	30S
	45-200	42.40	45	45L
	52-200	49.40	52	38S/42L

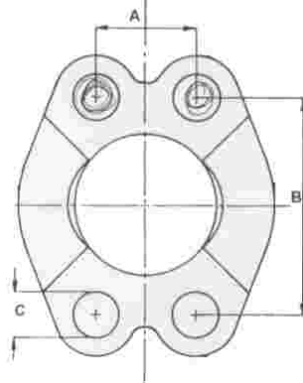
Brida	Pulgadas	A	B	C
Serie-3000 PSI 	1/2	17.40	38.10	M8
	3/4	22.20	47.60	M10
	1"	26.20	52.40	M10
	1"1/4	30.20	58.70	M10
	1"1/2	35.80	69.90	M12
	2"	42.80	77.80	M12
	2"1/2	50.80	88.90	M12
	3"	62.00	106.40	M16

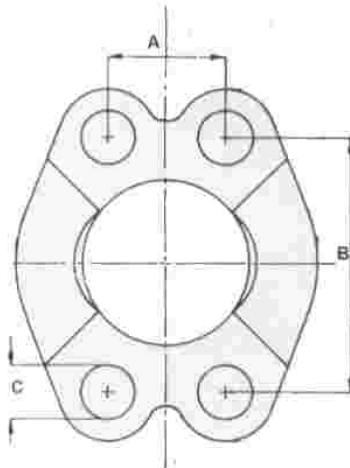
Brida	Pulgadas	A	B	C
Serie-6000 PSI 	1/2	18.20	40.50	M8
	3/4	23.80	50.80	M10
	1"	27.80	57.20	M12
	1"1/4	31.80	66.70	M14
	1"1/2	36.60	79.40	M16
	2"	44.40	96.80	M20



LONGITUDES DE TUBERÍA MONTADA

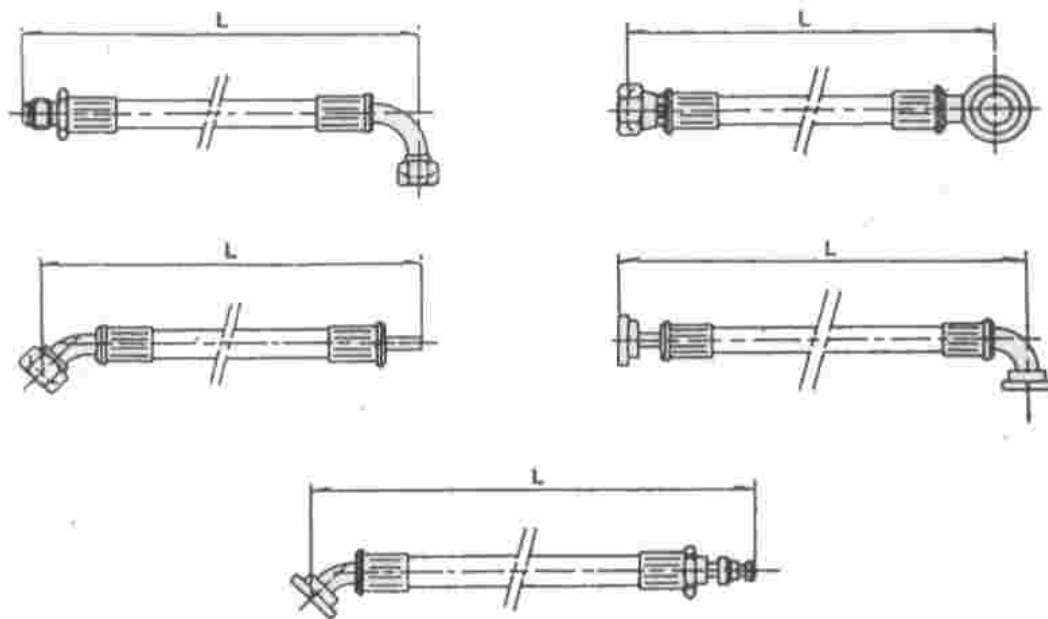

ANGULACIÓN RELATIVA DE DOS RACORES DE UN TUBO MONTADO

(En las figuras, se mantiene el racor trasero en la posición de las 12 horas y en el racor delantero marca la angulación relativa, siguiendo el sentido de las agujas del reloj).

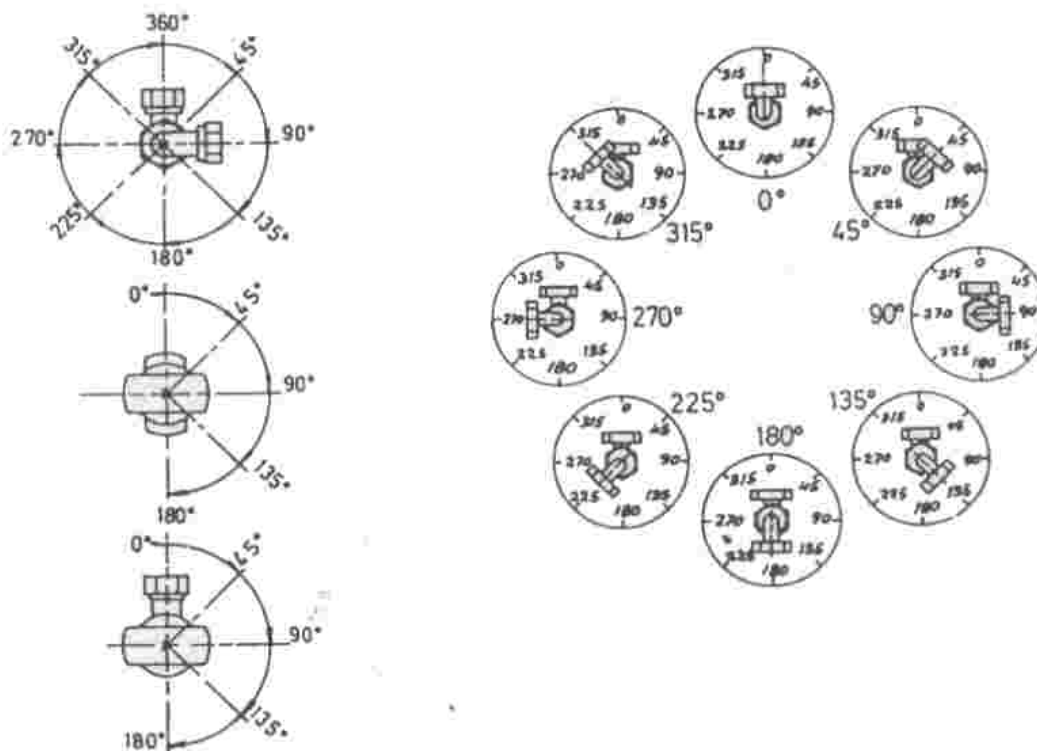

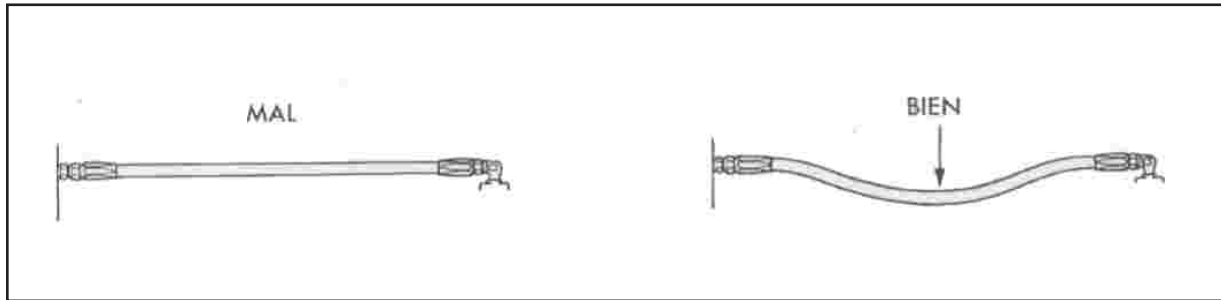

El tubo bajo presión cambia de longitud entre +2% y -4%. Instale los tubos con holgura.

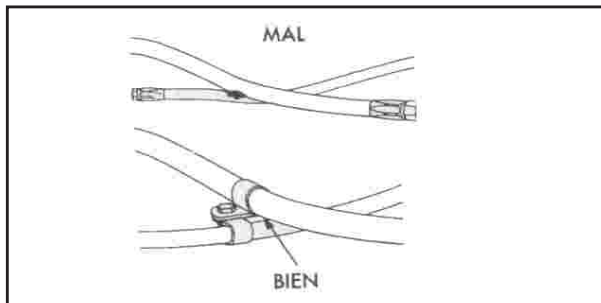

EVITE el roce de los flexibles entre sí sujetándolos con abrazaderas

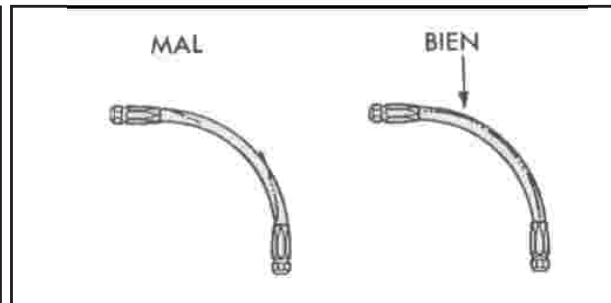

La torsión disminuye la resistencia del flexible a la presión. Existe además el peligro de que se aflojen las conexiones.

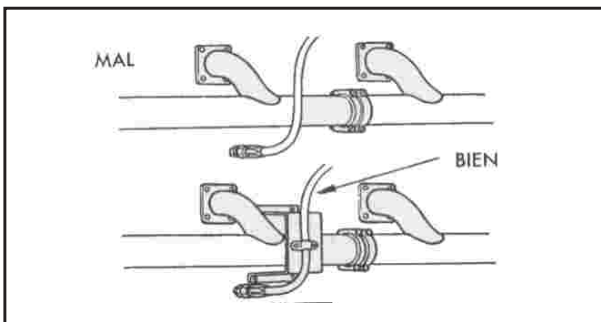

Proteja el flexible contra temperaturas elevadas.

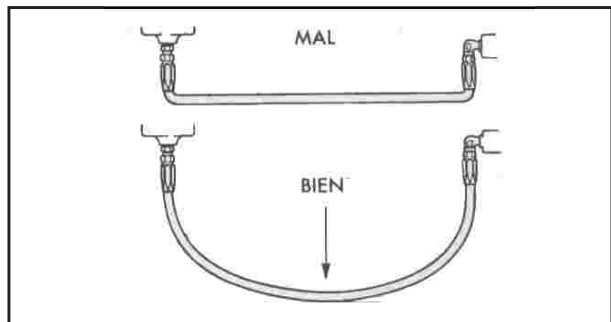

Evite la torsión por efecto del movimiento del flexible.

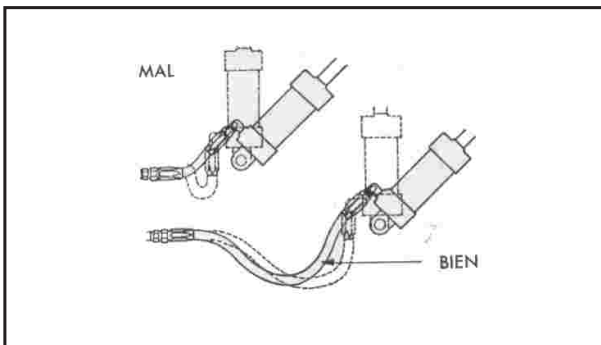

Respete los radios mínimos de curvatura del flexible teniendo en cuenta todas sus posiciones.

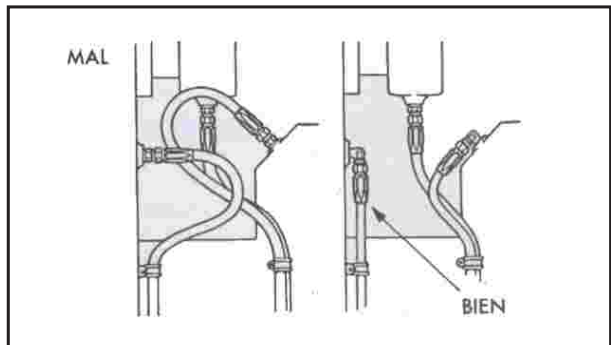

Use codos y adaptadores para conseguir montajes más limpios y correctos.

NOTA: Para la conducción de fluidos gaseosos a alta presión, la cubierta deberá estar microperforada para permitir la efusión del gas a través de la estructura del tubo.



RB6012

Tapón roscado hembra exagonal gas - BSPP



Código	Rosca	A.Carbón Precio €	A.Inox Precio €
RB6012 00 02	1/8		
RB6012 00 04	1/4		
RB6012 00 06	3/8		
RB6012 00 08	1/2		
RB6012 00 12	3/4		
RB6012 00 16	1"		
RB6012 00 20	1" 1/4		
RB6012 00 24	1" 1/2		
RB6012 00 32	2"		

RB6053

Tapón roscado tuerca giratoria con asiento cónico 60° gas - BSPP



Código	Rosca	A.Carbón Precio €	A.Inox Precio €
RB6053 00 04	1/4		
RB6053 00 06	3/8		
RB6053 00 08	1/2		
RB6053 00 12	3/4		
RB6053 00 16	1"		
RB6053 00 20	1" 1/4		
RB6053 00 24	1" 1/2		
RB6053 00 32	2"		

RB6013

Tapón roscado macho exagonal gas - BSPP



Código	Rosca	A.Carbón Precio €	A.Inox Precio €
RB6013 00 02	1/8		
RB6013 00 04	1/4		
RB6013 00 06	3/8		
RB6013 00 08	1/2		
RB6013 00 12	3/4		
RB6013 00 16	1"		
RB6013 00 20	1" 1/4		
RB6013 00 24	1" 1/2		
RB6013 00 32	2"		

RB6052

Tapón roscado macho con asiento cónico 60° gas - BSPP



Código	Rosca	A.Carbón Precio €	A.Inox Precio €
RB6052 00 04	1/4		
RB6052 00 06	3/8		
RB6052 00 08	1/2		
RB6052 00 12	3/4		
RB6052 00 16	1"		
RB6052 00 20	1" 1/4		
RB6052 00 24	1" 1/2		
RB6052 00 32	2"		

RB6014

Tapón roscado macho allen con balona gas - BSPP



Código	Rosca	A.Carbón Precio €	A.Inox Precio €
RB6014 00 02	1/8		
RB6014 00 04	1/4		
RB6014 00 06	3/8		
RB6014 00 08	1/2		
RB6014 00 12	3/4		
RB6014 00 16	1"		
RB6014 00 20	1" 1/4		

RB6015

Tapón roscado macho exagonal NPTF



Código	Rosca	A.Carbón Precio €	A.Inox Precio €
RB6015 00 02	1/8		
RB6015 00 04	1/4		
RB6015 00 06	3/8		
RB6015 00 08	1/2		
RB6015 00 12	3/4		
RB6015 00 16	1"		
RB6015 00 20	1" 1/4		
RB6015 00 24	1" 1/2		
RB6015 00 32	2"		

RB6060

Tapón roscado macho allen sin balona gas cónico - BSPT



Código	Rosca	A.Carbón Precio €	A.Inox Precio €
RB6060 00 02	1/8		
RB6060 00 04	1/4		
RB6060 00 06	3/8		
RB6060 00 08	1/2		
RB6060 00 12	3/4		
RB6060 00 16	1"		

RB6061

Tapón roscado macho allen sin balona NPTF



Código	Rosca	A.Carbón Precio €	A.Inox Precio €
RB6061 00 02	1/8		
RB6061 00 04	1/4		
RB6061 00 06	3/8		
RB6061 00 08	1/2		
RB6061 00 12	3/4		
RB6061 00 16	1"		

RACOR SERIE RB



RB6016

Tapón roscado reductor gas - BSPP



Código	Rosca Macho	Rosca Hembra	A.Carbono Precio €	A.Inox Precio €
RB6016 04 02	1/4	1/8		
RB6016 06 02	3/8	1/8		
RB6016 06 04	3/8	1/4		
RB6016 08 04	1/2	1/4		
RB6016 08 06	1/2	3/8		
RB6016 12 04	3/4	1/4		
RB6016 12 06	3/4	3/8		
RB6016 12 08	3/4	1/2		
RB6016 16 06	1"	3/8		
RB6016 16 08	1"	1/2		
RB6016 16 12	1"	3/4		
RB6016 20 12	1" 1/4	3/4		
RB6016 20 16	1" 1/4	1"		
RB6016 24 16	1" 1/2	1"		
RB6016 24 20	1" 1/2	1" 1/4		
RB6016 32 20	2"	1" 1/4		
RB6016 32 24	2"	1" 1/2		

RB6017

Suplemento roscadp macho fijo a tuerca fija gas - BSPP

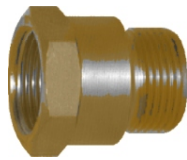

Código	Rosca Macho	Rosca Hembra	A.Carbono Precio €	A.Inox Precio €
RB6017 02 02	1/8	1/8		
RB6017 02 04	1/8	1/4		
RB6017 02 06	1/8	3/8		
RB6017 04 02	1/4	1/8		
RB6017 04 04	1/4	1/4		
RB6017 04 06	1/4	3/8		
RB6017 04 08	1/4	1/2		
RB6017 06 02	3/8	1/8		
RB6017 06 04	3/8	1/4		
RB6017 06 06	3/8	3/8		
RB6017 06 08	3/8	1/2		
RB6017 06 12	3/8	3/4		
RB6017 08 04	1/2	1/4		
RB6017 08 06	1/2	3/8		
RB6017 08 08	1/2	1/2		
RB6017 08 12	1/2	3/4		
RB6017 08 16	1/2	1"		
RB6017 12 06	3/4	3/8		
RB6017 12 08	3/4	1/2		
RB6017 12 12	3/4	3/4		
RB6017 12 16	3/4	1"		
RB6017 12 20	3/4	1" 1/4		
RB6017 16 08	1"	1/2		
RB6017 16 12	1"	3/4		
RB6017 16 16	1"	1"		
RB6017 16 20	1"	1" 1/4		
RB6017 16 24	1"	1" 1/2		
RB6017 20 12	1" 1/4	3/4		
RB6017 20 16	1" 1/4	1"		
RB6017 20 20	1" 1/4	1" 1/4		
RB6017 20 24	1" 1/4	1" 1/2		
RB6017 20 32	1" 1/4	2"		
RB6017 24 16	1" 1/2	1"		
RB6017 24 20	1" 1/2	1" 1/4		
RB6017 24 24	1" 1/2	1" 1/2		
RB6017 24 32	1" 1/2	2"		
RB6017 32 20	2"	1" 1/4		
RB6017 32 24	2"	1" 1/2		
RB6017 32 32	2"	2"		

RB6018

Unión macho fijo a macho fijo gas - BSPP

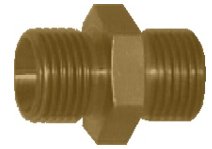

Código	Rosca Macho	Rosca Macho	A.Carbono Precio €	A.Inox Precio €
RB6018 02 02	1/8	1/8		
RB6018 02 04	1/8	1/4		
RB6018 02 06	1/8	3/8		
RB6018 04 04	1/4	1/4		
RB6018 04 06	1/4	3/8		
RB6018 04 08	1/4	1/2		
RB6018 04 12	1/4	3/4		
RB6018 06 06	3/8	3/8		
RB6018 06 08	3/8	1/2		
RB6018 06 12	3/8	3/4		
RB6018 08 08	1/2	1/2		
RB6018 08 10	1/2	5/8		
RB6018 08 12	1/2	3/4		
RB6018 08 16	1/2	1"		
RB6018 10 10	5/8	5/8		
RB6018 10 12	5/8	3/4		
RB6018 12 12	3/4	3/4		
RB6018 12 16	3/4	1"		
RB6018 12 20	3/4	1" 1/4		
RB6018 16 16	1"	1"		
RB6018 16 20	1"	1" 1/4		
RB6018 16 24	1"	1" 1/2		
RB6018 20 20	1" 1/4	1" 1/4		
RB6018 20 24	1" 1/4	1" 1/2		
RB6018 20 32	1" 1/4	2"		
RB6018 24 24	1" 1/2	1" 1/2		
RB6018 24 32	1" 1/2	2"		
RB6018 32 32	2"	2"		

RB6019

Unión macho fijo gas- BSPP a macho fijo NPTF

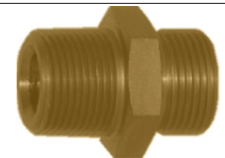

Código	Rosca BSPP	Rosca NPT	A.Carbono Precio €	A.Inox Precio €
RB6019 02 02	1/8	1/8		
RB6019 02 04	1/8	1/4		
RB6019 04 04	1/4	1/4		
RB6019 04 06	1/4	3/8		
RB6019 06 04	3/8	1/4		
RB6019 06 06	3/8	3/8		
RB6019 08 06	1/2	3/8		
RB6019 08 08	1/2	1/2		
RB6019 08 12	1/2	3/4		
RB6019 12 08	3/4	1/2		
RB6019 12 12	3/4	3/4		
RB6019 12 16	3/4	1"		
RB6019 16 12	1"	3/4		
RB6019 16 16	1"	1"		
RB6019 16 20	1"	1" 1/4		
RB6019 20 16	1" 1/4	1"		
RB6019 20 20	1" 1/4	1" 1/4		
RB6019 24 24	1" 1/2	1" 1/2		
RB6019 32 32	2"	2"		

RACOR SERIE RB

**RB6020**

Unión macho fijo a tuerca loca
gas - BSPP

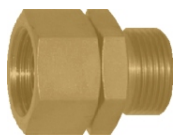

Código	Rosca Macho	Rosca Hembra	A.Carbono Precio €	A.Inox Precio €
RB6020 02 02	1/8	1/8		
RB6020 02 04	1/8	1/4		
RB6020 04 04	1/4	1/4		
RB6020 04 06	1/4	3/8		
RB6020 06 06	3/8	3/8		
RB6020 06 08	3/8	1/2		
RB6020 08 08	1/2	1/2		
RB6020 08 12	1/2	3/4		
RB6020 12 12	3/4	3/4		
RB6020 12 16	3/4	1"		
RB6020 16 16	1"	1"		
RB6020 16 20	1"	1" 1/4		
RB6020 20 20	1" 1/4	1" 1/4		
RB6020 20 24	1" 1/4	1" 1/2		
RB6020 24 24	1" 1/2	1" 1/2		

RB6021

Unión macho fijo NPTF a
tuerca loca gas - BSPP



Código	Rosca M. NPTF	Rosca H. BSPP	A.Carbono Precio €	A.Inox Precio €
RB6021 02 02	1/8	1/8		
RB6021 04 04	1/4	1/4		
RB6021 06 06	3/8	3/8		
RB6021 08 08	1/2	1/2		
RB6021 12 12	3/4	3/4		
RB6021 16 16	1"	1"		
RB6021 20 20	1" 1/4	1" 1/4		
RB6021 24 24	1" 1/2	1" 1/2		

RB6022

Unión tuerca loca a tuerca loca
gas - BSPP

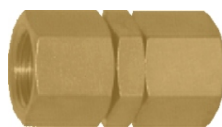

Código	Roscas	A.Carbono Precio €	A.Inox Precio €
RB6022 02 02	1/8		
RB6022 04 04	1/4		
RB6022 06 06	3/8		
RB6022 08 08	1/2		
RB6022 12 12	3/4		
RB6022 16 16	1"		
RB6022 20 20	1" 1/4		
RB6022 24 24	1" 1/2		

RB6023

Pasatabique con tuerca
gas - BSPP

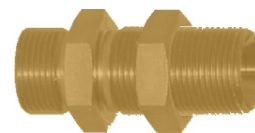

Código	Roscas	A.Carbono Precio €	A.Inox Precio €
RB6023 00 02	1/8		
RB6023 00 04	1/4		
RB6023 00 06	3/8		
RB6023 00 08	1/2		
RB6023 00 10	5/8		
RB6023 00 12	3/4		
RB6023 00 16	1"		
RB6023 00 20	1" 1/4		
RB6023 00 24	1" 1/2		
RB6023 00 32	2"		

RB6024

Tuerca para pasatabique
gas - BSPP



Código	Rosca	A.Carbono Precio €	A.Inox Precio €
RB6024 00 02	1/8		
RB6024 00 04	1/4		
RB6024 00 06	3/8		
RB6024 00 08	1/2		
RB6024 00 10	5/8		
RB6024 00 12	3/4		
RB6024 00 16	1"		
RB6024 00 20	1" 1/4		
RB6024 00 24	1" 1/2		
RB6024 00 32	2"		

RB6025

Tornillo simple
gas - BSPP



Código	Rosca	A.Carbono Precio €	A.Inox Precio €
RB6025 00 02	1/8		
RB6025 00 04	1/4		
RB6025 00 06	3/8		
RB6025 00 08	1/2		
RB6025 00 12	3/4		
RB6025 00 16	1"		
RB6025 00 20	1" 1/4		



RB6039

Te cuadrada
macho fijo - macho fijo - tuerca giratoria
lateral
gas - BSPP



Código	Roscas	A.Carbono Precio €	A.Inox Precio €
RB6039 02 02	1/8		
RB6039 04 04	1/4		
RB6039 06 06	3/8		
RB6039 08 08	1/2		
RB6039 12 12	3/4		
RB6039 16 16	1"		
RB6039 20 20	1" 1/4		
RB6039 24 24	1" 1/2		

RB6040

Te cuadrada
macho fijo - tuerca giratoria central -
macho fijo
gas - BSPP



Código	Roscas	A.Carbono Precio €	A.Inox Precio €
RB6040 02 02	1/8		
RB6040 04 04	1/4		
RB6040 06 06	3/8		
RB6040 08 08	1/2		
RB6040 12 12	3/4		
RB6040 16 16	1"		
RB6040 20 20	1" 1/4		
RB6040 24 24	1" 1/2		

RB6041

Te estampada
hembra fija - hembra fija - hembra fija
gas - BSPP

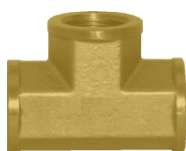

Código	Roscas	A.Carbono Precio €	A.Inox Precio €
RB6041 04 04	1/4		
RB6041 06 06	3/8		
RB6041 08 08	1/2		
RB6041 12 12	3/4		
RB6041 16 16	1"		
RB6041 20 20	1" 1/4		
RB6041 24 24	1" 1/2		

RB6045

Te estampada
macho fijo - macho fijo - macho fijo
gas - BSPP

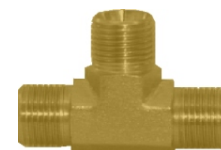

Código	Roscas	A.Carbono Precio €	A.Inox Precio €
RB6045 04 04	1/4		
RB6045 06 06	3/8		
RB6045 08 08	1/2		
RB6045 12 12	3/4		
RB6045 16 16	1"		
RB6045 20 20	1" 1/4		
RB6045 24 24	1" 1/2		

RB6046

Te estampada
macho fijo - macho fijo - tuerca giratoria
lateral
gas - BSPP

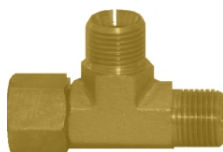

Código	Roscas	A.Carbono Precio €	A.Inox Precio €
RB6046 04 04	1/4		
RB6046 06 06	3/8		
RB6046 08 08	1/2		
RB6046 12 12	3/4		
RB6046 16 16	1"		
RB6046 20 20	1" 1/4		
RB6046 24 24	1" 1/2		

RB6047

Te estampada
macho fijo - tuerca giratoria central -
macho fijo
gas - BSPP

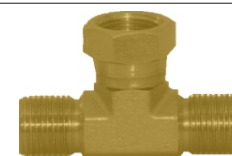

Código	Roscas	A.Carbono Precio €	A.Inox Precio €
RB6047 04 04	1/4		
RB6047 06 06	3/8		
RB6047 08 08	1/2		
RB6047 12 12	3/4		
RB6047 16 16	1"		
RB6047 20 20	1" 1/4		
RB6047 24 24	1" 1/2		

RB6042

Cruz macho fijo
gas - BSPP



Código	Roscas	A.Carbono Precio €	A.Inox Precio €
RB6042 02 02	1/8		
RB6042 04 04	1/4		
RB6042 06 06	3/8		
RB6042 08 08	1/2		
RB6042 12 12	3/4		
RB6042 16 16	1"		
RB6042 20 20	1" 1/4		
RB6042 24 24	1" 1/2		

RACOR SERIE RB

**RS7000**

Tuerca cono de ajuste
Rosca SAE



Código	Hembra SAE	A.Carbono Precio €	A.Inox Precio €
RS7000 00 04	7/16		
RS7000 00 05	1/2		
RS7000 00 06	9/16		
RS7000 00 08	3/4		
RS7000 00 10	7/8		
RS7000 00 12	1" 1/16		
RS7000 00 16	1" 5/16		
RS7000 00 20	1" 5/8		
RS7000 00 24	1" 7/8		

RS7001

Férula en pulgadas



Código	Ø pulgadas	A.Carbono Precio €	A.Inox Precio €
RS7001 00 04	7/16		
RS7001 00 05	1/2		
RS7001 00 06	9/16		
RS7001 00 08	3/4		
RS7001 00 10	7/8		
RS7001 00 12	1" 1/16		
RS7001 00 16	1" 5/16		
RS7001 00 20	1" 5/8		
RS7001 00 24	1" 7/8		

RS7037

Férula en milímetros



Código	Ø mm	Para Rosca	A.Carbono Precio €	A.Inox Precio €
RS7037 04 06	6	7/16		
RS7037 05 08	8	1/2		
RS7037 06 10	10	9/16		
RS7037 08 12	12	3/4		
RS7037 10 15	15	7/8		
RS7037 10 16	16	7/8		
RS7037 12 20	20	1" 1/16		
RS7037 16 25	25	1" 5/16		

RS7002

Macho soldable JIC



Código	Macho JIC	A.Carbono Precio €	A.Inox Precio €
RS7002 00 04	7/16		
RS7002 00 05	1/2		
RS7002 00 06	9/16		
RS7002 00 08	3/4		
RS7002 00 10	7/8		
RS7002 00 12	1" 1/16		
RS7002 00 16	1" 5/16		

RS7003

Tapón hembra JIC



Código	Hembra JIC	A.Carbono Precio €	A.Inox Precio €
RS7003 00 04	7/16		
RS7003 00 05	1/2		
RS7003 00 06	9/16		
RS7003 00 08	3/4		
RS7003 00 10	7/8		
RS7003 00 12	1" 1/16		
RS7003 00 16	1" 5/16		
RS7003 00 20	1" 5/8		
RS7003 00 24	1" 7/8		

RS7004

Tapón macho JIC



Código	Macho JIC	A.Carbono Precio €	A.Inox Precio €
RS7004 00 04	7/16		
RS7004 00 05	1/2		
RS7004 00 06	9/16		
RS7004 00 08	3/4		
RS7004 00 10	7/8		
RS7004 00 12	1" 1/16		
RS7004 00 16	1" 5/16		
RS7004 00 20	1" 5/8		
RS7004 00 24	1" 7/8		

**RS7008**

Unión
Macho JIC
Macho BSP



Código	Macho JIC	Macho BSP	A.Carbono Precio €	A.Inox Precio €
RS7008 04 02	7/16	1/8		
RS7008 04 04	7/16	1/4		
RS7008 04 06	7/16	3/8		
RS7008 04 08	7/16	1/2		
RS7008 04 12	7/16	3/4		
RS7008 05 04	1/2	1/4		
RS7008 05 06	1/2	3/8		
RS7008 05 08	1/2	1/2		
RS7008 06 04	9/16	1/4		
RS7008 06 06	9/16	3/8		
RS7008 06 08	9/16	1/2		
RS7008 08 04	3/4	1/4		
RS7008 08 06	3/4	3/8		
RS7008 08 08	3/4	1/2		
RS7008 08 12	3/4	3/4		
RS7008 10 06	7/8	3/8		
RS7008 10 08	7/8	1/2		
RS7008 10 12	7/8	3/4		
RS7008 10 16	7/8	1"		
RS7008 12 06	1" 1/16	3/8		
RS7008 12 08	1" 1/16	1/2		
RS7008 12 12	1" 1/16	3/4		
RS7008 12 16	1" 1/16	1"		
RS7008 16 12	1" 5/16	3/4		
RS7008 16 16	1" 5/16	1"		
RS7008 16 20	1" 5/16	1" 1/4		
RS7008 20 16	1" 5/8	1"		
RS7008 20 20	1" 5/8	1" 1/4		
RS7008 20 24	1" 5/8	1" 1/2		
RS7008 24 16	1" 7/8	1"		
RS7008 24 20	1" 7/8	1" 1/4		
RS7008 24 24	1" 7/8	1" 1/2		

RS7009

Unión
Macho JIC
Macho UNF



Código	Macho JIC	Macho UNF	A.Carbono Precio €	A.Inox Precio €
RS7009 04 04	7/16	7/16		
RS7009 04 05	7/16	1/2		
RS7009 04 06	7/16	9/16		
RS7009 05 05	1/2	1/2		
RS7009 05 06	1/2	9/16		
RS7009 06 05	9/16	1/2		
RS7009 06 06	9/16	9/16		
RS7009 06 08	9/16	3/4		
RS7009 06 10	9/16	7/8		
RS7009 08 06	3/4	9/16		
RS7009 08 08	3/4	3/4		
RS7009 08 10	3/4	7/8		
RS7009 08 12	3/4	1" 1/16		
RS7009 10 08	7/8	3/4		
RS7009 10 10	7/8	7/8		
RS7009 10 12	7/8	1" 1/16		
RS7009 12 08	1" 1/16	3/4		
RS7009 12 10	1" 1/16	7/8		
RS7009 12 12	1" 1/16	1" 1/16		
RS7009 12 16	1" 1/16	1" 5/16		
RS7009 16 12	1" 5/16	1" 1/16		
RS7009 16 16	1" 5/16	1" 5/16		
RS7009 16 20	1" 5/16	1" 5/8		
RS7009 20 16	1" 5/8	1" 5/16		
RS7009 20 20	1" 5/8	1" 5/8		
RS7009 20 24	1" 5/8	1" 7/8		
RS7009 24 20	1" 7/8	1" 5/8		
RS7009 24 24	1" 7/8	1" 7/8		

RS7010

Unión
Macho JIC
Macho métrico

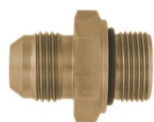

Código	Macho JIC	Macho métrico	A.Carbono Precio €	A.Inox Precio €
RS7010 04 10	7/16	10x100		
RS7010 04 12	7/16	12x150		
RS7010 05 12	1/2	12x150		
RS7010 05 14	1/2	14x150		
RS7010 06 12	9/16	12x150		
RS7010 06 14	9/16	14x150		
RS7010 06 16	9/16	16x150		
RS7010 06 18	9/16	18x150		
RS7010 08 14	3/4	14x150		
RS7010 08 16	3/4	16x150		
RS7010 08 18	3/4	18x150		
RS7010 08 22	3/4	22x150		
RS7010 08 26	3/4	26x150		
RS7010 10 18	7/8	18x150		
RS7010 10 22	7/8	22x150		
RS7010 12 18	1" 1/16	18x150		
RS7010 12 22	1" 1/16	22x150		
RS7010 12 26	1" 1/16	26x150		
RS7010 16 26	1" 5/16	26x150		

RS7011

Unión
Macho JIC
Macho NPTF



Código	Macho JIC	Macho NPTF	A.Carbono Precio €	A.Inox Precio €
RS7011 04 02	7/16	1/8		
RS7011 04 04	7/16	1/4		
RS7011 05 02	1/2	1/8		
RS7011 05 04	1/2	1/4		
RS7011 06 02	9/16	1/8		
RS7011 06 04	9/16	1/4		
RS7011 06 06	9/16	3/8		
RS7011 06 08	9/16	1/2		
RS7011 08 06	3/4	3/8		
RS7011 08 08	3/4	1/2		
RS7011 08 12	3/4	3/4		
RS7011 10 06	7/8	3/8		
RS7011 10 08	7/8	1/2		
RS7011 10 12	7/8	3/4		
RS7011 12 08	1" 1/16	1/2		
RS7011 12 12	1" 1/16	3/4		
RS7011 12 16	1" 1/16	1"		
RS7011 16 12	1" 5/16	3/4		
RS7011 16 16	1" 5/16	1"		
RS7011 16 20	1" 5/16	1" 1/4		
RS7011 20 16	1" 5/8	1"		
RS7011 20 20	1" 5/8	1" 1/4		
RS7011 24 20	1" 7/8	1" 1/4		
RS7011 24 24	1" 7/8	1" 1/2		



RS7013

Reducción
Macho JIC
Hembra JIC



Código	Hembra JIC	Macho JIC	A.Carbono Precio €	A.Inox Precio €
RS7013 05 04	1/2	7/16		
RS7013 06 04	9/16	7/16		
RS7013 06 05	9/16	1/2		
RS7013 08 04	3/4	7/16		
RS7013 08 05	3/4	1/2		
RS7013 08 06	3/4	9/16		
RS7013 08 10	3/4	7/8		
RS7013 08 12	3/4	1" 1/16		
RS7013 10 04	7/8	7/16		
RS7013 10 05	7/8	1/2		
RS7013 10 06	7/8	9/16		
RS7013 10 08	7/8	3/4		
RS7013 12 04	1" 1/16	7/16		
RS7013 12 06	1" 1/16	9/16		
RS7013 12 08	1" 1/16	3/4		
RS7013 12 10	1" 1/16	7/8		
RS7013 16 08	1" 5/16	3/4		
RS7013 16 10	1" 5/16	7/8		
RS7013 16 12	1" 5/16	1" 1/16		
RS7013 20 10	1" 5/8	7/8		
RS7013 20 12	1" 5/8	1" 1/16		
RS7013 20 16	1" 5/8	1" 5/16		
RS7013 24 16	1" 7/8	1" 5/16		
RS7013 24 20	1" 7/8	1" 5/8		

RS7014

Unión
Hembra giratoria JIC
Macho BSPP

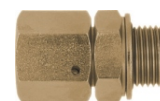

Código	Hembra JIC	Macho BSPP	A.Carbono Precio €	A.Inox Precio €
RS7014 04 02	7/16	1/8		
RS7014 04 04	7/16	1/4		
RS7014 04 06	7/16	3/8		
RS7014 05 04	1/2	1/4		
RS7014 05 06	1/2	3/8		
RS7014 06 04	9/16	1/4		
RS7014 06 06	9/16	3/8		
RS7014 08 04	3/4	1/4		
RS7014 08 06	3/4	3/8		
RS7014 08 08	3/4	1/2		
RS7014 08 12	3/4	3/4		
RS7014 10 06	7/8	3/8		
RS7014 10 08	7/8	1/2		
RS7014 10 12	7/8	3/4		
RS7014 12 08	1" 1/16	1/2		
RS7014 12 12	1" 1/16	3/4		
RS7014 12 16	1" 1/16	1"		
RS7014 16 12	1" 5/16	3/4		
RS7014 16 16	1" 5/16	1"		
RS7014 16 20	1" 5/16	1" 1/4		
RS7014 20 16	1" 5/8	1"		
RS7014 20 20	1" 5/8	1" 1/4		
RS7014 20 24	1" 5/8	1" 1/2		
RS7014 24 20	1" 7/8	1" 1/4		
RS7014 24 24	1" 7/8	1" 1/2		

RS7056

Unión
Hembra giratoria JIC
Macho UNF

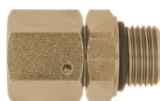

Código	Hembra JIC	Macho UNF	A.Carbono Precio €	A.Inox Precio €
RS7056 04 04	7/16	7/16	6,40	
RS7056 04 05	7/16	1/2	6,75	
RS7056 05 05	1/2	1/2	7,55	
RS7056 06 06	9/16	9/16	7,25	
RS7056 06 08	9/16	3/4	7,60	
RS7056 08 06	3/4	9/16	7,60	
RS7056 08 08	3/4	3/4	7,80	
RS7056 08 10	3/4	7/8	8,50	
RS7056 10 08	7/8	3/4	8,15	
RS7056 10 10	7/8	7/8	8,40	
RS7056 10 12	7/8	1" 1/16	14,90	
RS7056 12 10	1" 1/16	7/8	10,30	
RS7056 12 12	1" 1/16	1" 1/16	14,65	
RS7056 12 16	1" 1/16	1" 5/16	29,30	
RS7056 16 12	1" 5/16	1" 1/16	17,65	
RS7056 16 16	1" 5/16	1" 5/16	26,45	
RS7056 16 20	1" 5/16	1" 5/8	32,55	
RS7056 20 16	1" 5/8	1" 5/16	29,80	
RS7056 20 20	1" 5/8	1" 5/8	32,55	
RS7056 20 24	1" 5/8	1" 7/8	52,85	
RS7056 24 20	1" 7/8	1" 5/8	40,10	
RS7056 24 24	1" 7/8	1" 7/8	54,50	

RS7053

Unión
Hembra giratoria JIC
Macho métrico

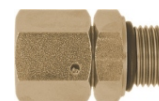

Código	Hembra JIC	Macho métrico	A.Carbono Precio €	A.Inox Precio €
RS7053 04 10	7/16	10x100		
RS7053 04 12	7/16	12x150		
RS7053 05 12	1/2	12x150		
RS7053 06 14	9/16	14x150		
RS7053 06 16	9/16	16x150		
RS7053 08 16	3/4	16x150		
RS7053 08 18	3/4	18x150		
RS7053 10 18	7/8	18x150		
RS7053 10 22	7/8	22x150		
RS7053 12 22	1" 1/16	22x150		
RS7053 12 27	1" 1/16	27x200		
RS7053 16 27	1" 5/16	27x200		
RS7053 16 33	1" 5/16	33x200		



RS7076

Unión
Macho JIC
Hembra BSPT

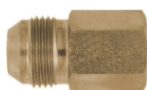

Código	Macho JIC	Hembra BSPT	A.Carbono Precio €	A.Inox Precio €
RS7076 04 02	7/16	1/8	4,60	
RS7076 04 04	7/16	1/4	6,75	
RS7076 05 02	1/2	1/8	4,60	
RS7076 06 04	9/16	1/4	8,15	
RS7076 06 06	9/16	3/8	7,30	
RS7076 08 04	3/4	1/4	8,95	
RS7076 08 06	3/4	3/8	6,10	
RS7076 08 08	3/4	1/2	10,05	
RS7076 10 06	7/8	3/8	8,15	
RS7076 10 08	7/8	1/2	12,50	
RS7076 12 08	1" 1/16	1/2	12,20	
RS7076 12 12	1" 1/16	3/4	13,55	
RS7076 16 12	1" 5/16	3/4	14,90	
RS7076 16 16	1" 5/16	1"	23,55	
RS7076 20 16	1" 5/8	1"	27,10	
RS7076 20 20	1" 5/8	1" 1/4	25,80	
RS7076 24 24	1" 7/8	1" 1/2	46,10	

RS7016

Unión
Hembra giratoria - Hembra giratoria JIC



Código	Hembra JIC	A.Carbono Precio €	A.Inox Precio €
RS7016 04 04	7/16		
RS7016 05 05	1/2		
RS7016 06 06	9/16		
RS7016 08 08	3/4		
RS7016 10 10	7/8		
RS7016 12 12	1" 1/16		
RS7016 16 16	1" 5/16		

RS7072

Adaptador toma de presión
Hembra JIC
Hembra BSPP



Código	Hembra JIC	Hembra BSPP	A.Carbono Precio €	A.Inox Precio €
RS7072 04 04	7/16	1/4		
RS7072 05 04	1/2	1/4		
RS7072 06 04	9/16	1/4		
RS7072 08 04	3/4	1/4		
RS7072 10 04	7/8	1/4		
RS7072 12 04	1" 1/16	1/4		
RS7072 16 04	1" 5/16	1/4		
RS7072 20 04	1" 5/8	1/4		
RS7072 24 04	1" 7/8	1/4		

RS7073

Adaptador toma de presión
Hembra JIC
Hembra NPTF



Código	Hembra JIC	Hembra NPTF	A.Carbono Precio €	A.Inox Precio €
RS7073 10 02	7/8	1/8		
RS7073 12 04	1" 1/16	1/4		
RS7073 16 04	1" 5/16	1/4		
RS7073 16 06	1" 5/16	3/8		
RS7073 16 08	1" 5/16	1/2		

RS7017

Codo 90°
Macho - Macho JIC

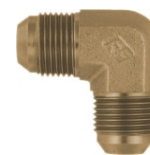

Código	Macho JIC	A.Carbono Precio €	A.Inox Precio €
RS7017 04 04	7/16		
RS7017 05 05	1/2		
RS7017 06 06	9/16		
RS7017 08 08	3/4		
RS7017 10 10	7/8		
RS7017 12 12	1" 1/16		
RS7017 16 16	1" 5/16		
RS7017 20 20	1" 5/8		
RS7017 24 24	1" 7/8		



RS7018

Codo 90°
Macho JIC
Macho orientable BSPP



Código	Macho JIC	Macho BSPP	A.Carbono Precio €	A.Inox Precio €
RS7018 04 02	7/16	1/8		
RS7018 04 04	7/16	1/4		
RS7018 04 06	7/16	3/8		
RS7018 05 04	1/2	1/4		
RS7018 05 06	1/2	3/8		
RS7018 06 04	9/16	1/4		
RS7018 06 06	9/16	3/8		
RS7018 06 08	9/16	1/2		
RS7018 08 04	3/4	1/4		
RS7018 08 06	3/4	3/8		
RS7018 08 08	3/4	1/2		
RS7018 08 12	3/4	3/4		
RS7018 10 06	7/8	3/8		
RS7018 10 08	7/8	1/2		
RS7018 10 12	7/8	3/4		
RS7018 12 08	1" 1/16	1/2		
RS7018 12 12	1" 1/16	3/4		
RS7018 12 16	1" 1/16	1"		
RS7018 16 12	1" 5/16	3/4		
RS7018 16 16	1" 5/16	1"		
RS7018 16 20	1" 5/16	1" 1/4		
RS7018 20 16	1" 5/8	1"		
RS7018 20 20	1" 5/8	1" 1/4		
RS7018 20 24	1" 5/8	1" 1/2		
RS7018 24 20	1" 7/8	1" 1/4		
RS7018 24 24	1" 7/8	1" 1/2		

RS7019

Codo 90°
Macho JIC
Macho orientable UNF

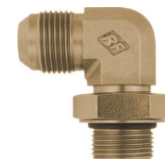

Código	Macho JIC	Macho UNF	A.Carbono Precio €	A.Inox Precio €
RS7019 04 04	7/16	7/16		
RS7019 04 05	7/16	1/2		
RS7019 04 06	7/16	9/16		
RS7019 05 04	1/2	7/16		
RS7019 05 05	1/2	1/2		
RS7019 06 06	9/16	9/16		
RS7019 06 08	9/16	3/4		
RS7019 06 10	9/16	7/8		
RS7019 08 06	3/4	9/16		
RS7019 08 08	3/4	3/4		
RS7019 08 10	3/4	7/8		
RS7019 10 08	7/8	3/4		
RS7019 10 10	7/8	7/8		
RS7019 10 12	7/8	1" 1/16		
RS7019 12 10	1" 1/16	7/8		
RS7019 12 12	1" 1/16	1" 1/16		
RS7019 12 16	1" 1/16	1" 5/16		
RS7019 16 12	1" 5/16	1" 1/16		
RS7019 16 16	1" 5/16	1" 5/16		
RS7019 16 20	1" 5/16	1" 5/8		
RS7019 20 16	1" 5/8	1" 5/16		
RS7019 20 20	1" 5/8	1" 5/8		
RS7019 20 24	1" 5/8	1" 7/8		
RS7019 24 20	1" 7/8	1" 5/8		
RS7019 24 24	1" 7/8	1" 7/8		

RS7048

Codo 90°
Macho JIC
Macho orientable métrico

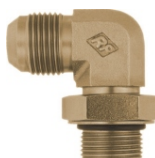

Código	Macho JIC	Macho métrico	A.Carbono Precio €	A.Inox Precio €
RS7048 04 10	7/16	10x100		
RS7048 04 12	7/16	12x150		
RS7048 04 14	7/16	14x150		
RS7048 05 10	1/2	10x100		
RS7048 05 12	1/2	12x150		
RS7048 06 14	9/16	14x150		
RS7048 06 16	9/16	16x150		
RS7048 08 16	3/4	16x150		
RS7048 08 18	3/4	18x150		
RS7048 10 18	7/8	18x150		
RS7048 10 22	7/8	22x150		
RS7048 12 22	1" 1/16	22x150		
RS7048 12 27	1" 1/16	27x200		
RS7048 12 33	1" 1/16	33x200		
RS7048 16 27	1" 5/16	27x200		
RS7048 16 33	1" 5/16	33x200		

RS7045

Codo 90° largo
Macho JIC
Macho orientable BSPP



Código	Macho JIC	Macho BSPP	A.Carbono Precio €	A.Inox Precio €
RS7045 06 06	9/16	3/8		
RS7045 08 06	3/4	3/8		
RS7045 08 08	3/4	1/2		
RS7045 10 08	7/8	1/2		

RS7047

Codo 90° largo
Macho JIC
Macho orientable métrico



Código	Macho JIC	Macho métrico	A.Carbono Precio €	A.Inox Precio €
RS7047 08 18	7/16	10x100		
RS7047 10 22	7/8	22x150		

RACOR SERIE RS



RS7070

Codo 90°
Macho JIC
Hembra fija NPTF

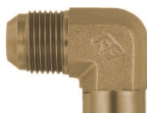

Código	Macho JIC	Hembra NPTF	A.Carbono Precio €	A.Inox Precio €
RS7070 04 02	7/16	1/8		
RS7070 05 04	1/2	1/4		
RS7070 06 04	9/16	1/4		
RS7070 06 06	9/16	3/8		
RS7070 08 04	3/4	1/4		
RS7070 08 06	3/4	3/8		
RS7070 08 08	3/4	1/2		
RS7070 10 06	7/8	3/8		
RS7070 10 08	7/8	1/2		
RS7070 12 08	1" 1/16	1/2		
RS7070 12 12	1" 1/16	3/4		
RS7070 16 16	1" 5/16	1"		
RS7070 20 20	1" 5/8	1" 1/4		

RS7071

Codo 90°
Macho JIC
Hembra fija BSPT

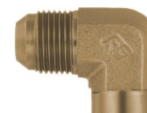

Código	Macho JIC	Hembra BSPT	A.Carbono Precio €	A.Inox Precio €
RS7071 04 02	7/16	1/8		
RS7071 05 04	1/2	1/4		
RS7071 06 04	9/16	1/4		
RS7071 06 06	9/16	3/8		
RS7071 08 04	3/4	1/4		
RS7071 08 06	3/4	3/8		
RS7071 08 08	3/4	1/2		
RS7071 10 06	7/8	3/8		
RS7071 10 08	7/8	1/2		
RS7071 12 08	1" 1/16	1/2		
RS7071 12 12	1" 1/16	3/4		
RS7071 16 16	1" 5/16	1"		
RS7071 20 20	1" 5/8	1" 1/4		

RS7074

Codo 90°
Macho JIC
Encaste soldar

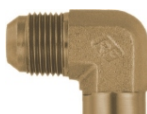

Código	Roscas JIC	A.Carbono Precio €	A.Inox Precio €
RS7074 00 05	1/2		
RS7074 00 06	9/16		
RS7074 00 08	3/4		
RS7074 00 10	7/8		
RS7074 00 12	1" 1/16		

RS7024

Codo 45°
Macho JIC
Macho orientable BSPP



Código	Hembra JIC	Macho BSPP	A.Carbono Precio €	A.Inox Precio €
RS7024 04 02	7/16	1/8		
RS7024 04 04	7/16	1/4		
RS7024 05 04	1/2	1/4		
RS7024 06 02	9/16	1/8		
RS7024 06 04	9/16	1/4		
RS7024 06 06	9/16	3/8		
RS7024 08 04	3/4	1/4		
RS7024 08 06	3/4	3/8		
RS7024 08 08	3/4	1/2		
RS7024 10 06	7/8	3/8		
RS7024 10 08	7/8	1/2		
RS7024 10 12	7/8	3/4		
RS7024 12 08	1" 1/16	1/2		
RS7024 12 12	1" 1/16	3/4		
RS7024 12 16	1" 1/16	1"		
RS7024 16 12	1" 5/16	3/4		
RS7024 16 16	1" 5/16	1"		
RS7024 16 20	1" 5/16	1" 1/4		
RS7024 20 16	1" 5/8	1"		
RS7024 20 20	1" 5/8	1" 1/4		

RS7043

Codo 45°
Macho JIC
Macho pasatabique JIC

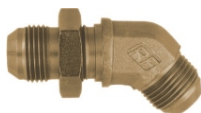

Código	Roscas JIC	A.Carbono Precio €	A.Inox Precio €
RS7043 08 08	3/4	12,95	
RS7043 10 10	7/8	16,15	
RS7043 12 12	1" 1/16	23,05	

RACOR SERIE RS



RS7025

Codo 45°
Macho JIC
Macho orientable UNF



Código	Macho JIC	Macho UNF	A.Carbono Precio €	A.Inox Precio €
RS7025 04 04	7/16	7/16		
RS7025 05 05	1/2	1/2		
RS7025 06 06	9/16	9/16		
RS7025 06 08	9/16	3/4		
RS7025 08 08	3/4	3/4		
RS7025 08 10	3/4	7/8		
RS7025 10 08	7/8	3/4		
RS7025 10 10	7/8	7/8		
RS7025 10 12	7/8	1" 1/16		
RS7025 12 10	1" 1/16	7/8		
RS7025 12 12	1" 1/16	1" 1/16		
RS7025 12 16	1" 1/16	1" 5/16		
RS7025 16 12	1" 5/16	1" 1/16		
RS7025 16 16	1" 5/16	1" 5/16		

RS7049

Codo 45°
Macho JIC
Macho orientable métrico



Código	Macho JIC	Macho métrico	A.Carbono Precio €	A.Inox Precio €
RS7049 04 10	7/16	10x100		
RS7049 05 14	1/2	14x150		
RS7049 06 14	9/16	14x150		
RS7049 06 16	9/16	16x150		
RS7049 08 16	3/4	16x150		
RS7049 08 18	3/4	18x150		
RS7049 10 18	7/8	18x150		
RS7049 10 22	7/8	22x150		
RS7049 10 27	7/8	27x200		
RS7049 12 22	1" 1/16	22x150		
RS7049 12 27	1" 1/16	27x200		
RS7049 12 33	1" 1/16	33x200		
RS7049 16 27	1" 5/16	27x200		
RS7049 16 33	1" 5/16	33x200		

RS7027

Codo 45°
Macho JIC
Hembra giratoria JIC



Código	Roscas JIC	A.Carbono Precio €	A.Inox Precio €
RS7027 04 04	7/16		
RS7027 05 05	1/2		
RS7027 06 06	9/16		
RS7027 08 08	3/4		
RS7027 10 10	7/8		
RS7027 12 12	1" 1/16		
RS7027 16 16	1" 5/16		
RS7027 20 20	1" 5/8		
RS7027 24 24	1" 7/8		

RS7026

Codo 45°
Macho JIC
Macho NPTF



Código	Macho JIC	Macho NPTF	A.Carbono Precio €	A.Inox Precio €
RS7026 04 02	7/16	1/8		
RS7026 04 04	7/16	1/4		
RS7026 05 02	1/2	1/8		
RS7026 05 04	1/2	1/4		
RS7026 06 02	9/16	1/8		
RS7026 06 04	9/16	1/4		
RS7026 06 06	9/16	3/8		
RS7026 08 04	3/4	1/4		
RS7026 08 06	3/4	3/8		
RS7026 08 08	3/4	1/2		
RS7026 10 06	7/8	3/8		
RS7026 10 08	7/8	1/2		
RS7026 10 12	7/8	3/4		
RS7026 12 08	1" 1/16	1/2		
RS7026 12 12	1" 1/16	3/4		
RS7026 16 12	1" 5/16	3/4		
RS7026 16 16	1" 5/16	1"		

RS7064

Codo 45°
Macho JIC
Macho BSPT



Código	Macho JIC	Macho BSPT	A.Carbono Precio €	A.Inox Precio €
RS7064 04 02	7/16	1/8		
RS7064 04 04	7/16	1/4		
RS7064 05 04	1/2	1/4		
RS7064 06 02	9/16	1/8		
RS7064 06 04	9/16	1/4		
RS7064 06 06	9/16	3/8		
RS7064 06 08	9/16	1/2		
RS7064 08 04	3/4	1/4		
RS7064 08 06	3/4	3/8		
RS7064 08 08	3/4	1/2		
RS7064 10 06	7/8	3/8		
RS7064 10 08	7/8	1/2		
RS7064 10 12	7/8	3/4		
RS7064 12 08	1" 1/16	1/2		
RS7064 12 12	1" 1/16	3/4		
RS7064 16 12	1" 5/16	3/4		
RS7064 16 16	1" 5/16	1"		

RACOR SERIE RS



RS7051

Te
Macho JIC
Macho orientable central métrico



Código	Machos JIC	Macho métrico	A.Carbono Precio €	A.Inox Precio €
RS7051 04 10	7/16	10x100		
RS7051 05 12	1/2	12x150		
RS7051 06 14	9/16	14x150		
RS7051 06 16	9/16	16x150		
RS7051 08 16	3/4	16x150		
RS7051 08 18	3/4	18x150		
RS7051 10 18	7/8	18x150		
RS7051 10 22	7/8	22x150		
RS7051 12 27	1" 1/16	27x200		
RS7051 16 33	1" 5/16	33x200		
RS7051 20 42	1" 5/8	42x200		
RS7051 24 48	1" 7/8	48x200		

RS7034

Te
Macho JIC
Macho orientable central UNF



Código	Machos JIC	Macho UNF	A.Carbono Precio €	A.Inox Precio €
RS7034 04 04	7/16	7/16		
RS7034 05 05	1/2	1/2		
RS7034 06 06	9/16	9/16		
RS7034 06 08	9/16	3/4		
RS7034 08 08	3/4	3/4		
RS7034 08 10	3/4	7/8		
RS7034 10 08	7/8	3/4		
RS7034 10 10	7/8	7/8		
RS7034 10 12	7/8	1" 1/16		
RS7034 12 10	1" 1/16	7/8		
RS7034 12 12	1" 1/16	1" 1/16		
RS7034 16 16	1" 5/16	1" 5/16		

RS7035

Te
Macho JIC
Macho lateral NPTF



Código	Machos JIC	Macho NPTF	A.Carbono Precio €	A.Inox Precio €
RS7035 04 02	7/16	1/8		
RS7035 05 02	1/2	1/8		
RS7035 06 04	9/16	1/4		
RS7035 06 06	9/16	3/8		
RS7035 08 06	3/4	3/8		
RS7035 08 08	3/4	1/2		
RS7035 10 08	7/8	1/2		
RS7035 12 12	1" 1/16	3/4		
RS7035 16 16	1" 5/16	1"		

RS7033

Te
Macho JIC
Macho orientable lateral UNF



Código	Machos JIC	Macho UNF	A.Carbono Precio €	A.Inox Precio €
RS7033 04 04	7/16	7/16		
RS7033 05 05	1/2	1/2		
RS7033 06 06	9/16	9/16		
RS7033 06 08	9/16	3/4		
RS7033 08 08	3/4	3/4		
RS7033 08 10	3/4	7/8		
RS7033 10 10	7/8	7/8		
RS7033 10 12	7/8	1" 1/16		
RS7033 12 10	1" 1/16	7/8		
RS7033 12 12	1" 1/16	1" 1/16		
RS7033 12 16	1" 1/16	1" 5/16		
RS7033 16 12	1" 5/16	1" 1/16		
RS7033 16 16	1" 5/16	1" 5/16		

RS7062

Te
Macho JIC
Macho lateral BSPT





Código	Machos JIC	Macho BSPT	A.Carbono Precio €	A.Inox Precio €
RS7062 04 02	7/16	1/8		
RS7062 04 04	7/16	1/4		
RS7062 05 04	1/2	1/4		
RS7062 06 04	9/16	1/4		
RS7062 08 04	3/4	1/4		
RS7062 08 06	3/4	3/8		
RS7062 08 08	3/4	1/2		
RS7062 10 08	7/8	1/2		
RS7062 10 12	7/8	3/4		
RS7062 12 12	1" 1/16	3/4		
RS7062 12 16	1" 1/16	1"		
RS7062 16 12	1" 5/16	3/4		
RS7062 16 16	1" 5/16	1"		
RS7062 20 16	1" 5/8	1"		
RS7062 20 20	1" 5/8	1" 1/4		
RS7062 20 24	1" 5/8	1" 1/2		
RS7062 24 20	1" 7/8	1" 1/4		
RS7062 24 24	1" 7/8	1" 1/2		

RACOR SERIE RS





Racor Serie RO

Tipo	Código	Dia. Ø	Precio €
RO7100 Asiento soldar 	RO7100 06 04	6	
	RO7100 08 06	8	
	RO7100 10 06	10	
	RO7100 12 08	12	
	RO7100 14 10	14	
	RO7100 15 10	16	
	RO7100 20 12	20	
	RO7100 25 16	25	
	RO7100 32 20	32	
	RO7100 38 24	38	

	Código	Rosca H.	Precio €
RO7101 Tuerca 	RO7101 00 04	9/16-18	
	RO7101 00 06	11/16-16	
	RO7101 00 08	13/16-16	
	RO7101 00 10	1"-14	
	RO7101 00 12	1"3/16-12	
	RO7101 00 16	1"7/16-12	
	RO7101 00 20	1"11/16-12	
	RO7101 00 24	2"-12	

	Código	Rosca H.	Precio €
RO7102 Tapón hembra 	RO7102 00 04	9/16-18	
	RO7102 00 06	11/16-16	
	RO7102 00 08	13/16-16	
	RO7102 00 10	1"-14	
	RO7102 00 12	1"3/16-12	
	RO7102 00 16	1"7/16-12	
	RO7102 00 20	1"11/16-12	
	RO7102 00 24	2"-12	

	Código	Rosca M.	Precio €
RO7103 Tapón macho 	RO7103 00 04	9/16-18	
	RO7103 00 06	11/16-16	
	RO7103 00 08	13/16-16	
	RO7103 00 10	1"-14	
	RO7103 00 12	1"3/16-12	
	RO7103 00 16	1"7/16-12	
	RO7103 00 20	1"11/16-12	
	RO7103 00 24	2"-12	

	Código	Rosca M.	Precio €
RO7104 Macho soldar 	RO7104 00 04	9/16-18	
	RO7104 00 06	11/16-16	
	RO7104 00 08	13/16-16	
	RO7104 00 10	1"-14	
	RO7104 00 12	1"3/16-12	
	RO7104 00 16	1"7/16-12	
	RO7104 00 20	1"11/16-12	
	RO7104 00 24	2"-12	

Racor Serie RO





Tipo	Código	Ambas roscas ORFS	Precio €
RO7105 Racor unión ORFS 	RO7105 00 04	9/16-18	
	RO7105 00 06	11/16-16	
	RO7105 00 08	13/16-16	
	RO7105 00 10	1"-14	
	RO7105 00 12	1"3/16-12	
	RO7105 00 16	1"7/16-12	
	RO7105 00 20	1"11/16-12	
	RO7105 00 24	2"-12	

Tipo	Código	Rosca M/ORFS	Rosca M/BSP	Precio €
RO7106 Racor unión ORFS X BSP 	RO7106 04 02	9/16-18	1/8	
	RO7106 04 04	9/16-18	1/4	
	RO7106 04 06	9/16-18	3/8	
	RO7106 04 08	9/16-18	1/2	
	RO7106 06 04	11/16-16	1/4	
	RO7106 06 06	11/16-16	3/8	
	RO7106 06 08	11/16-16	1/2	
	RO7106 08 04	13/16-16	1/4	
	RO7106 08 06	13/16-16	3/8	
	RO7106 08 12	13/16-16	3/4	
	RO7106 10 06	1"-14	3/8	
	RO7106 10 08	1"-14	1/2	
	RO7106 10 12	1"-14	3/4	
	RO7106 10 16	1"-14	1"	
	RO7106 12 08	1"3/16-12	1/2	
	RO7106 12 12	1"3/16-12	3/4	
	RO7106 12 16	1"3/16-12	1"	
	RO7106 12 20	1"3/16-12	1"1/4	
	RO7106 16 12	1"7/16-12	3/4	
	RO7106 16 16	1"7/16-12	1"	
	RO7106 16 20	1"7/16-12	1"1/4	
	RO7106 20 16	1"11/16-12	1"	
	RO7106 20 20	1"11/16-12	1"1/4	
	RO7106 20 24	1"11/16-12	1"1/2	
RO7106 24 20	2"-12	1"1/4		
RO7106 24 24	2"-12	1"1/2		



Racor Serie RO

Tipo	Código	Rosca M/ORFS	Rosca M/NPT	Precio €
RO7107 Racor unión ORFS/NPT 	RO7107 04 02	9/16-18	1/8	
	RO7107 04 04	9/16-18	1/4	
	RO7107 06 04	11/16-16	1/4	
	RO7107 06 06	11/16-16	3/8	
	RO7107 08 06	13/16-16	3/8	
	RO7107 08 08	13/16-16	1/2	
	RO7107 10 08	1"-14	1/2	
	RO7107 12 12	1"3/16-12	3/4	
	RO7107 16 16	1"7/16-12	1"	

Tipo	Código	Rosca M/ORFS	Rosca M/UNF	Precio €
RO7108 Racor unión ORFS/UNF 	RO7108 04 04	9/16-18	7/16 UNF	
	RO7108 04 06	9/16-18	9/16 UNF	
	RO7108 06 04	11/16-16	7/16 UNF	
	RO7108 06 06	11/16-16	9/16 UNF	
	RO7108 06 08	11/16-16	3/4 UNF	
	RO7108 08 06	13/16-16	9/16 UNF	
	RO7108 08 08	13/16-16	3/4 UNF	
	RO7108 08 10	13/16-16	7/8 UNF	
	RO7108 10 08	1"-14	3/4 UNF	
	RO7108 10 10	1"-14	7/8 UNF	
	RO7108 10 12	1"-14	1"1/16 UNF	
	RO7108 12 10	1"3/16-12	7/8 UNF	
	RO7108 12 12	1"3/16-12	1"1/16 UNF	
	RO7108 12 16	1"3/16-12	1"5/16 UNF	
	RO7108 16 16	1"7/16-12	1"5/16 UNF	
	RO7108 16 20	1"7/16-12	1"5/8 UNF	
	RO7108 20 20	1"11/16-12	1"5/8 UNF	
	RO7108 20 24	1"11/16-12	1"7/8 UNF	
	RO7108 24 24	2"-12	1"7/8 UNF	

Racor Serie RO



Tipo	Código	Ambas roscas ORFS	Precio €
RO7109 Pasamuro ORFS 	RO7109 00 04	9/16-18	
	RO7109 00 06	11/16-16	
	RO7109 00 08	13/16-16	
	RO7109 00 10	1"-14	
	RO7109 00 12	1"3/16-12	
	RO7109 00 16	1"7/16-12	

		Parte Macho	Parte Hembra	
RO7142 Reductor MACHO HEMBRA ORFS 	RO7142 04 06	9/16-18	11/16-16	
	RO7142 04 08	9/16-18	13/16-16	
	RO7142 04 10	9/16-18	1-14	
	RO7142 06 08	11/16-16	13/16	
	RO7142 06 10	11/16-16	1-14	
	RO7142 06 12	11/16-16	1"3/16-12	
	RO7142 08 10	13/16-16	1-14	
	RO7142 08 12	13/16-16	1"3/16	
	RO7142 10 12	1"-14	1"3/16	
	RO7142 10 16	1"-14	1"7/16-12	
	RO7142 12 16	1"3/16-12	1"7/16-12	
	RO7142 12 20	1"3/16-12	1"11/16-12	
	RO7142 16 20	1"7/16-12	1"11/16-12	
	RO7142 16 24	1"7/16-12	2-12	
RO7142 20 24	1"11/16-12	2-12		

RO7180 Adaptador HG ORFS MF Gas 	RO7180 04 04	9/16-18	1/4	
	RO7180 06 04	11/16-16	1/4	
	RO7180 06 06	11/16-16	3/8	
	RO7180 08 06	13/16-16	3/8	
	RO7180 08 08	13/16-16	1/2	
	RO7180 10 08	1"14	1/2	
	RO7180 10 12	1"14	3/4	
	RO7180 12 08	1"3/16-12	1/2	
	RO7180 12 12	1"3/16-12	3/4	
	RO7180 16 12	1"7/16-12	3/4	
	RO7180 16 16	1"7/16-12	1"	

RO7181 Adaptador HG ORFS MF/UNF 	RO7181 04 04	9/16-18	7/16	
	RO7181 06 04	11/16-16	7/16	
	RO7181 06 06	11/16-16	9/16	
	RO7181 08 06	13/16-16	9/16	
	RO7181 08 08	13/16-16	3/4	
	RO7181 10 08	1"-14	3/4	
	RO7181 10 12	1"-14	1"11/16	
	RO7181 12 08	1"3/16-12	3/4	
	RO7181 12 12	1"3/16-12	1"11/16	
	RO7181 16 12	1"7/16-12	1"11/16	
	RO7181 16 16	1"7/16-12	1"5/16	
RO7181 10 10	1"-14	7/8		



Racor Serie RO

Tipo	Código	Ambas roscas	Precio €
RO7150 Codo 45 MF/HG ORFS 	RO7150 00 04	9/16-18	
	RO7150 00 06	11/16-16	
	RO7150 00 08	13/16-16	
	RO7150 00 10	1"-14	
	RO7150 00 12	1"3/16-12	
	RO7150 00 16	1"7/16-12	
	RO7150 00 20	1"11/16-12	

	Código	Ambas roscas	Rosca orientable BSP	
RO7151 Codo 45 orientable MF ORFS M/ ari gas 	RO7151 04 02	9/16-18	1/8	
	RO7151 04 04	9/16-18	1/4	
	RO7151 06 04	11/16-16	1/4	
	RO7151 06 06	11/16-16	3/8	
	RO7151 08 06	13/16-16	3/8	
	RO7151 08 08	13/16-16	1/2	
	RO7151 10 08	1"-14	1/2	
	RO7151 10 12	1"-14	3/4	
	RO7151 12 08	1"3/16-12	1/2	
	RO7151 12 12	1"3/16-12	3/4	
	RO7151 16 12	1"7/16-12	3/4	
	RO7151 16 16	1"7/16-12	1	

			UNF	
RO7152 Codo orientable ORFS UNF 	RO7152 04 04	9/16-18	7/16	
	RO7152 06 04	11/16-16	7/16	
	RO7152 06 06	11/16-16	9/16	
	RO7152 08 06	13/16-16	9/16	
	RO7152 08 08	13/16-16	3/4	
	RO7152 08 10	13/16-16	7/8	
	RO7152 10 08	1"-14	3/4	
	RO7152 10 10	1"-14	7/8	
	RO7152 10 12	1"-14	1"1/16	
	RO7152 12 10	1"3/16-12	7/8	
	RO7152 12 12	1"3/16-12	1"1/16	
	RO7152 16 12	1"7/16-12	1"1/16	
	RO7152 16 16	1"7/16-12	1"5/16	

Racor Serie RO



Tipo	Código	Ambas roscas	Rosca Orientable BSP	Precio €
RO7135 Te orientable lateral BSP 	RO7135 04 04	9/16-18	1/4	
	RO7135 06 04	11/16-16	1/4	
	RO7135 06 06	11/16-16	3/8	
	RO7135 08 06	13/16-16	3/8	
	RO7135 08 08	13/16-16	1/2	
	RO7135 10 08	1"-14	1/2	
	RO7135 10 12	1"-14	3/4	
	RO7135 12 12	1"3/16-12	3/4	
	RO7135 16 12	1"7/16-12	3/4	
	RO7135 16 16	1"7/16-12	1"	

		Ambas roscas	Rosca Orientable BSP	
RO7134 Te orientable central BSP 	RO7134 04 04	9/16-18	1/4	
	RO7134 06 04	11/16-16	1/4	
	RO7134 06 06	11/16-16	3/8	
	RO7134 08 06	13/16-16	3/8	
	RO7134 08 08	13/16-16	1/2	
	RO7134 10 08	1"-14	1/2	
	RO7134 10 12	1"-14	3/4	
	RO7134 12 12	1"3/16-12	3/4	
	RO7134 16 12	1"7/16-12	3/4	
	RO7134 16 16	1"7/16-12	1"	

		Ambas roscas	Rosca Orientable UNF	
RO7136 Te orientable central UNF 	RO7136 04 04	9/16-18	7/16	
	RO7136 06 04	11/16-16	7/16	
	RO7136 06 06	11/16-16	9/16	
	RO7136 08 06	13/16-16	9/16	
	RO7136 08 08	13/16-16	3/4	
	RO7136 10 10	1"-14	7/8	
	RO7136 10 12	1"-14	1"1/16	
	RO7136 12 12	1"3/16-12	1"1/16	
	RO7136 16 12	1"7/16-12	1"1/16	
	RO7136 16 16	1"7/16-12	1"5/16	

		Ambas roscas	Rosca Orientable UNF	
RO7137 Te orientable lateral UNF 	RO7137 04 04	9/16-18	7/16	
	RO7137 06 04	11/16-16	7/16	
	RO7137 06 06	11/16-16	9/16	
	RO7137 08 06	13/16-16	9/16	
	RO7137 08 08	13/16-16	3/4	
	RO7137 10 10	1"-14	7/8	
	RO7137 10 12	1"-14	1"1/16	
	RO7137 12 12	1"3/16-12	1"1/16	
	RO7137 16 12	1"7/16-12	1"1/16	
	RO7137 16 16	1"7/16-12	1"5/16	



Racor Serie RO

Tipo	Código	Ambas roscas/ORFS	Precio €	
RO7110 Codo M-M ORFS 	RO7110 00 04	9/16-18		
	RO7110 00 06	11/16-16		
	RO7110 00 08	13/16-16		
	RO7110 00 10	1"-14		
	RO7110 00 12	1"3/16-12		
	RO7110 00 16	1"7/16-12		
	RO7110 00 20	1"11/16-12		
	RO7110 00 24	2"-12		

		Ambas roscas/ORFS		
RO7111 Codo M HG ORFS 	RO7111 00 04	9/16-18		
	RO7111 00 06	11/16-16		
	RO7111 00 08	13/16-16		
	RO7111 00 10	1"-14		
	RO7111 00 12	1"3/16-12		
	RO7111 00 16	1"7/16-12		
	RO7111 00 20	1"11/16-12		
	RO7111 00 24	2"-12		

		Ambas roscas/ORFS		
RO7112 Codo pasatabique ORFS 	RO7112 00 04	9/16-18		
	RO7112 00 06	11/16-16		
	RO7112 00 08	13/16-16		
	RO7112 00 10	1"-14		
	RO7112 00 12	1"3/16-12		
	RO7112 00 16	1"7/16-12		
	RO7112 00 20	1"11/16-12		
	RO7112 00 24	2"-12		

Racor Serie RO





Tipo	Código	R.M. ORFS	R.M. BSP	Precio €
RO7113 Codo M ORFS orientable BSP 	RO7113 04 02	9/16-18	1/8	
	RO7113 04 04	9/16-18	1/4	
	RO7113 04 06	9/16-18	3/8	
	RO7113 06 04	11/16-16	1/4	
	RO7113 06 06	11/16-16	3/8	
	RO7113 06 08	11/16-16	1/2	
	RO7113 08 04	13/16-16	1/4	
	RO7113 08 06	13/16-16	3/8	
	RO7113 08 08	13/16-16	1/2	
	RO7113 10 06	1"-14	3/8	
	RO7113 10 08	1"-14	1/2	
	RO7113 10 12	1"-14	3/4	
	RO7113 10 16	1"-14	1"	
	RO7113 12 08	1"3/16-12	1/2	
	RO7113 12 12	1"3/16-12	3/4	
	RO7113 12 16	1"3/16-12	1	
	RO7113 16 12	1"7/16-12	3/4	
	RO7113 16 16	1"7/16-12	1	
	RO7113 16 20	1"7/16-12	1"1/4	
	RO7113 20 20	1"11/16-12	1"1/4	
	RO7113 20 24	1"11/16-12	1"1/2	
	RO7113 24 20	2"-12	1"1/4	

Tipo	Código	R.M. ORFS	R.M. UNF	Precio €	
RO7114 Codo M ORFS orientable UNF 	RO7114 04 04	9/16-18	7/16		
	RO7114 04 06	9/16-18	9/16		
	RO7114 06 06	11/16-16	9/16		
	RO7114 06 08	11/16-16	3/4		
	RO7114 06 10	11/16-16	7/8		
	RO7114 08 06	13/16-16	9/16		
	RO7114 08 08	13/16-16	3/4		
	RO7114 08 10	13/16-16	7/8		
	RO7114 10 08	1"-14	3/4		
	RO7114 10 10	1"-14	7/8		
	RO7114 10 12	1"-14	1"1/16		
	RO7114 12 10	1"3/16-12	7/8		
	RO7114 12 12	1"3/16-12	1"1/16		
	RO7114 12 16	1"3/16-12	1"5/16		
	RO7114 16 12	1"7/16-12	1"1/16		
	RO7114 16 16	1"7/16-12	1"5/16		
	RO7114 16 20	1"7/16-12	1"5/8		
	RO7114 20 16	1"11/16-12	1"5/16		
	RO7114 20 20	1"11/16-12	1"5/8		
	RO7114 20 24	1"11/16-12	1"7/8		
	RO7114 24 20	2"-12	1"5/8		



Racor Serie RO

Tipo	Código	Ambas roscas/ORFS	Precio €
RO7115 Te M-M-M ORFS 	RO7115 04 04	9/16-18	
	RO7115 06 06	11/16-16	
	RO7115 08 08	13/16-16	
	RO7115 10 10	1"-14	
	RO7115 12 12	1"3/16-12	
	RO7115 16 16	1"7/16-12	

		Ambas roscas/ORFS	
RO7116 Te M-M-HG central ORFS 	RO7116 04 04	9/16-18	
	RO7116 06 06	11/16-16	
	RO7116 08 08	13/16-16	
	RO7116 10 10	1"-14	
	RO7116 12 12	1"3/16-12	
	RO7116 16 16	1"7/16-12	

		Ambas roscas/ORFS	
RO7117 Te M-M-HG lateral ORFS 	RO7117 04 04	9/16-18	
	RO7117 06 60	11/16-16	
	RO7117 08 08	13/16-16	
	RO7117 10 10	1"-14	
	RO7117 12 12	1"3/16-12	
	RO7117 16 16	1"7/16-12	

Racor Serie RO





Tipo	Código	Rosca ORFS	Rosca orientable METRICO	Precio €	
RO7122 CODO ORIENTABLE MF ORFS X METRICO 	RO7122 04 10	9/16-18	10-100		
	RO7122 04 12	9/16-18	12-150		
	RO7122 04 14	9/16-18	14-150		
	RO7122 06 14	11/16-16	14-150		
	RO7122 06 16	11/16-16	16-150		
	RO7122 08 16	13/16-16	16-150		
	RO7122 08 18	13/16-16	18-150		
	RO7122 08 22	13/16-16	22-150		
	RO7122 10 18	1"-14-14	18-150		
	RO7122 10 22	1"-14-14	22-150		
	RO7122 10 27	1"-14-14	27-200		
	RO7122 12 27	1"3/16-12	27-200		
	RO7122 16 33	1"7/16-12	33-200		
	RO7122 20 48	1"11/16-12	48-200		
	RO7122 24 42	2"-12	42-200		
	RO7122 24 48	2"-12	48-200		

Tipo	Código	Rosca ORFS	Rosca NPT	Precio €
RO7119 Codo ORFS/NPT 	RO7119 04 02	9/16-18	1/8	
	RO7119 04 04	9/16-18	1/4	
	RO7119 06 02	11/16-16	1/8	
	RO7119 06 04	11/16-16	1/4	
	RO7119 06 06	11/16-16	3/8	
	RO7119 06 08	11/16-16	1/2	
	RO7119 08 04	13/16-16	1/4	
	RO7119 08 06	13/16-16	3/8	
	RO7119 08 08	13/16-16	1/2	
	RO7119 10 06	1"-14	3/8	
	RO7119 10 08	1"-14	1/2	
	RO7119 10 12	1"-14	3/4	
	RO7119 12 12	1"3/16-12	3/4	
	RO7119 12 16	1"3/16-12	1"	
	RO7119 16 16	1"7/16-12	1"	
	RO7119 16 20	1"7/16-12	1"1/4	
	RO7119 20 16	1"11/16-12	1"	
	RO7119 20 20	1"11/16-12	1"1/4	
	RO7119 20 24	1"11/16-12	1"1/2	
	RO7119 24 24	2"-12	1"1/2	



Racor Serie RD

Tipo	Código	Referencia	Acero PVP €	Inox PVP €
TUERCA M 	RD10000004	M-4LL (8X1)		
	RD10000006	M-6LL (10X1)		
	RD10000008	M-8LL (12X1)		
	RD10000010	M-10LL (14X1)		
	RD10000012	M-12LL (16X1)		
	RD10010006	M-6L (12X1,5)		
	RD10010008	M-8L (14X1,5)		
	RD10010010	M-10L (16X1,5)		
	RD10010012	M-12L (18X1,5)		
	RD10010015	M-15L (22X1,5)		
	RD10010018	M-18L (26X1,5)		
	RD10010022	M-22L (30X2)		
	RD10010028	M-28L (36X2)		
	RD10010035	M-35L (45X2)		
	RD10010042	M-42L (52X2)		
	RD10020006	M-6S (14X1,5)		
	RD10020008	M-8S (16X1,5)		
	RD10020010	M-10S (18X1,5)		
	RD10020012	M-12S (20X1,5)		
	RD10020014	M-14S (22X1,5)		
	RD10020016	M-16S (24X1,5)		
	RD10020020	M-20S (30X2)		
	RD10020025	M-25S (36X2)		
	RD10020030	M-30S (42X2)		
	RD10020038	M-38S (52X2)		

Tipo	Código	Referencia	Acero PVP €	Inox PVP €
ANILLO CORTANTE D 	RD20000004	D-4LL (8X1)		
	RD20000006	D-6LL (10X1)		
	RD20000008	D-8LL (12X1)		
	RD20000010	D-10LL (14X1)		
	RD20000012	D-12LL (16X1)		
	RD20010006	D-6LS (12X1,5)		
	RD20010008	D-8LS (14X1,5)		
	RD20010010	D-10LS (16X1,5)		
	RD20010012	D-12LS (18X1,5)		
	RD20010015	D-15L (22X1,5)		
	RD20010018	D-18L (26X1,5)		
	RD20010022	D-22L (30X2)		
	RD20010028	D-28L (36X2)		
	RD20010035	D-35L (45X2)		
	RD20010042	D-42L (52X2)		
	RD20020014	D-14S (14X1,5)		
	RD20020016	D-16S (16X1,5)		
	RD20020020	D-20S (18X1,5)		
	RD20020025	D-25S (20X1,5)		
	RD20020030	D-30S (22X1,5)		
	RD20020038	D-38S (24X1,5)		

Nota: Racores Inox
Codigo sustituir RD por RN





Tipo	Código	Referencia	Acero PVP €	Inox PVP €	
Anillo de FUGA CERO 	RD2004 0006	ES4-6LS			
	RD2004 0008	ES4-8LS			
	RD2004 0010	ES4-10LS			
	RD2004 0012	ES4-12LS			
	RD20040015	ES4-15L			
	RD20040018	ES4-18L			
	RD20040022	ES4-22L			
	RD20040028	ES4-28L			
	RD20040035	ES4-35L			
	RD20040042	ES4-42L			
	RD20040014	ES4-14S			
	RD20040016	ES4-16S			
	RD20040020	ES4-20S			
	RD20040025	ES4-25S			
	RD20040030	ES4-30S			
	RD20040038	ES4-38S			

Tipo	Código	Referencia	Acero PVP €	Inox PVP €	
AS 	RD3111 0600	AS-6L			
	RD3111 0800	AS-8L			
	RD3111 1000	AS-10L			
	RD3111 1200	AS-12L			
	RD3111 1500	AS-15L			
	RD31111800	AS-18L			
	RD31112200	AS-22L			
	RD31112800	AS-28L			
	RD31113500	AS-35L			
	RD31114200	AS-42L			
	RD31120600	AS-6S			
	RD31120800	AS-8S			
	RD31121000	AS-10S			
	RD31121200	AS-12S			
	RD31121400	AS-14S			
	RD31121600	AS-16S			
	RD31122000	AS-20S			
	RD31122500	AS-25S			
	RD31123000	AS-30S			
	RD31123800	AS-38S			





Racor Serie RD

Tipo	Código	Referencia	Acero PVP €	Inox PVP €	
GE Racor recto rosca gas cilíndrica 	RD31110602	GE-6LR (1/8)			
	RD31110804	GE-8LR (1/4)			
	RD31111004	GE-10LR (1/4)			
	RD31111206	GE-12LR (3/8)			
	RD31111508	GE-15LR (1/2)			
	RD31111808	GE-18LR (1/2)			
	RD31112212	GE-22LR (3/4)			
	RD31112816	GE-28LR (1")			
	RD31113520	GE-35LR (1"1/4)			
	RD31114224	GE-42LR (1"1/2)			
	RD31120604	GE-6SR (1/4)			
	RD31120804	GE-8SR (1/4)			
	RD31121006	GE-10SR (3/8)			
	RD31121206	GE-12SR (3/8)			
	RD31121408	GE-14SR (1/2)			
	RD31121608	GE-16SR (1/2)			
	RD31122012	GE-20SR (3/4)			
	RD31122516	GE-25SR (1")			
	RD31123020	GE-30SR (1"1/4)			
	RD31123824	GE-38SR (1"1/2)			

Tipo	Código	Referencia	Acero PVP €	Inox PVP €
GE-R Racor recto rosca gas cilíndrica especial 	RD31110604	GE-R-6LR 1/4		
	RD31110606	GE-R-6LR 3/8		
	RD31110802	GE-R-8LR 1/8		
	RD31110806	GE-R-8LR 3/8		
	RD31110808	GE-R-8LR 1/2		
	RD31111002	GE-R-10LR 1/8		
	RD31111006	GE-R-10LR 3/8		
	RD31111008	GE-R-10LR 1/2		
	RD31111204	GE-R-12LR 1/4		
	RD31111208	GE-R-12LR 1/2		
	RD31111506	GE-R-15LR 3/8		
	RD31111512	GE-R-15LR 3/4		
	RD31111806	GE-R-18LR 3/8		
	RD31111812	GE-R-18LR 3/4		
	RD31112208	GE-R-22LR 1/2		
	RD31112216	GE-R-22LR 1"		
	RD31112812	GE-R-28LR 3/4		
	RD31113516	GE-R-35LR 1"		
	RD31114220	GE-R-42LR 1"1/4		
	RD31120606	GE-R-6SR 3/8		
	RD31120608	GE-R-6SR 1/2		
	RD31120806	GE-R-8SR 3/8		
	RD31121004	GE-R-10SR 1/4		
	RD31121008	GE-R-10SR 1/2		
	RD31121204	GE-R-12SR 1/4		
	RD31121208	GE-R-12SR 1/2		
	RD31121406	GE-R-14SR 3/8		
	RD31121606	GE-R-16SR 3/8		
	RD31121612	GE-R-16SR 3/4		
	RD31122008	GE-R-20SR 1/2		
	RD31122016	GE-R-20SR 1"		
	RD31122512	GE-R-25SR 3/4		
	RD31123016	GE-R-30SR 1"		
RD31123820	GE-R-38SR 1"1/4			





Tipo	Código	Referencia	Acero PVP €	Inox PVP €	
GE-M Racor recto rosca métrica cilíndrica 	RD31410610	GE-6LM (10X1)			
	RD31410812	GE- 8LM (12X1,5)			
	RD31411014	GE- 10LM (14X1,5)			
	RD31411216	GE- 12LM (16X1,5)			
	RD31411518	GE- 15LM (18X1,5)			
	RD31411822	GE- 18LM (22X1,5)			
	RD31412226	GE- 22LM (26X1,5)			
	RD31412833	GE- 28LM (33X2)			
	RD31413542	GE- 35LM (42X2)			
	RD31414248	GE- 42LM (48X2)			
	RD31420612	GE- 6SM (12X1.5)			
	RD31420814	GE- 8SM (14X1.5)			
	RD31421016	GE- 10SM (16X1.5)			
	RD31421218	GE- 12SM (18X1.5)			
	RD31421420	GE- 14SM (20X1.5)			
	RD31421622	GE- 16SM (22X1.5)			
	RD31422027	GE- 20SM (27X2)			
	RD31422533	GE- 25SM (33X2)			
	RD31423042	GE- 30SM (42X2)			
	RD31423848	GE- 38SM (48X2)			

Tipo	Código	Referencia	Acero PVP €	Inox PVP €	
GE Racor recto rosca métrica cilíndrica especial 	RD31410814	GE- 8LM (14X1,5)			
	RD31410816	GE- 8LM (16X1,5)			
	RD31411016	GE- 10LM (16X1,5)			
	RD31411018	GE- 10LM (18X1,5)			
	RD31411022	GE- 10LM (22X1,5)			
	RD31411214	GE- 12LM (14X1,5)			
	RD31411218	GE- 12LM (18X1,5)			
	RD31411222	GE- 12LM (22X1,5)			
	RD31411516	GE- 15LM (16X1,5)			
	RD31411522	GE- 15LM (22X1,5)			
	RD31411818	GE- 18LM (18X1,5)			
	RD31411826	GE- 18LM (26X1,5)			
	RD31412222	GE- 22LM (22X1,5)			
	RD31412122	GE- 12SM (22X1,5)			
	RD31421618	GE- 16SM (18X1,5)			
	RD31422527	GE- 25SM (27X2)			





Racor Serie RD

Tipo	Código	Referencia	Acero PVP €	Inox PVP €	
GE-ED Racor recto con junta rosca gas cilíndrica 	RD61110602	GE-6LR (1/8)			
	RD61110804	GE-8LR (1/4)			
	RD61111004	GE-10LR (1/4)			
	RD61111206	GE-12LR (3/8)			
	RD61111508	GE-15LR (1/2)			
	RD61111808	GE-18LR (1/2)			
	RD61112212	GE-22LR (3/4)			
	RD61112816	GE-28LR (1")			
	RD61113520	GE-35LR (1"1/4)			
	RD61114224	GE-42LR (1"1/2)			
	RD61120604	GE-6SR (1/4)			
	RD61120804	GE-8SR (1/4)			
	RD61121006	GE-10SR (3/8)			
	RD61121206	GE-12SR (3/8)			
	RD61121408	GE-14SR (1/2)			
	RD61121608	GE-16SR (1/2)			
	RD61122012	GE-20SR (3/4)			
	RD61122516	GE-25SR (1")			
	RD61123020	GE-30SR (1"1/4)			
	RD61123824	GE-38SR (1"1/2)			

Tipo	Código	Referencia	Acero PVP €	Inox PVP €	
GE-ED Racor recto con junta rosca métrica cilíndrica 	RD61110610	GE-6LM (10X1,5)			
	RD61110812	GE- 8LM (12X1,5)			
	RD61111014	GE- 10LM (14X1,5)			
	RD61111216	GE- 12LM (16X1,5)			
	RD61111518	GE- 15LM (18X1,5)			
	RD61111822	GE- 18LM (22X1,5)			
	RD61112226	GE- 22LM (26X1,5)			
	RD61112833	GE- 28LM (33X2)			
	RD61113542	GE- 35LM (42X2)			
	RD61114248	GE- 42LM (48X2)			
	RD61120612	GE- 6SM (12X1,5)			
	RD61120814	GE- 8SM (14X1,5)			
	RD61121016	GE- 10SM (16X1,5)			
	RD61121218	GE- 12SM (18X1,5)			
	RD61121420	GE- 14SM (20X1,5)			
	RD61121622	GE- 16SM (22X1,5)			
	RD61122027	GE- 20SM (27X2)			
	RD61122533	GE- 25SM (33X2)			
	RD61123042	GE- 30SM (42X2)			
	RD61123848	GE- 38SM (48X2)			





<p>GE-K</p> <p>Racor recto rosca gas cónica</p> 	RD31200402	GE-4LLRK (1/8)		
	RD31200602	GE-6LLRK (1/8)		
	RD31200802	GE-8LLRK (1/8)		
	RD31201004	GE-10LLRK (1/4)		
	RD31201204	GE-12LLRK (1/4)		
	RD31210602	GE-6LRK (1/8)		
	RD31210804	GE-8LRK (1/4)		
	RD31211004	GE-10LRK (1/4)		
	RD31211206	GE-12LRK (3/8)		
	RD31211508	GE-15LRK (1/2)		
	RD31211808	GE-18LRK (1/2)		
	RD31212212	GE-22LRK (3/4)		
	RD31212816	GE-28LRK (1")		
	RD31213520	GE-35LRK (1"1/4)		
	RD31214224	GE-42LRK (1"1/2)		
	RD31220604	GE-6SRK (1/4)		
	RD31220804	GE-8SRK (1/4)		
	RD31221006	GE-10SRK (3/8)		
	RD31221206	GE-12SRK (3/8)		
	RD31221408	GE-14SRK (1/2)		
	RD31221608	GE-16SRK (1/2)		
	RD31222012	GE-20SRK (3/4)		
	RD31222516	GE-25SRK (1")		
	RD31223020	GE-30SRK (1"1/4)		
RD31223824	GE-38SRK (1"1/2)			

Tipo	Código	Referencia	Acero PVP €	Inox PVP €
<p>GE-K</p> <p>Racor recto rosca gas cónica especial</p> 	RD31120804	GE-8LLRK (1/4)		
	RD31121206	GE-12LLRK (3/8)		
	RD31210604	GE-6LRK (1/4)		
	RD31210802	GE-8LRK (1/8)		
	RD31210806	GE-8LRK (3/8)		
	RD31210808	GE-8LRK (1/2)		
	RD31211002	GE-10LRK (1/8)		
	RD31211006	GE-10LRK (3/8)		
	RD31211008	GE-10LRK (1/2)		
	RD31211204	GE-12LRK (1/4)		
	RD31211208	GE-12LRK (1/2)		
	RD31211506	GE-15LRK (3/8)		
	RD31211806	GE-18LRK (3/8)		
	RD31211812	GE-18LRK (3/4)		
	RD31221004	GE-10SRK (1/4)		
	RD31221008	GE-10SRK (1/2)		
	RD31221204	GE-12SRK (1/4)		
	RD31221208	GE-12SRK (1/2)		
	RD31221406	GE-14SRK (3/8)		
	RD31221606	GE-16SRK (3/8)		
	RD31222008	GE-20SRK (1/2)		
	RD31222512	GE-25SRK (3/4)		
	RD31223016	GE-30SRK (1")		
	RD31223820	GE-38SRK (1"1/4)		



Racor Serie RD

<p>GE</p> <p>Racor recto rosca NPT</p> 	RD31300402	GE-4LLNPT (1/8)	
	RD31300802	GE-8LLNPT (1/8)	
	RD31310602	GE-6LNPT (1/8)	
	RD31311004	GE-10LNPT (1/4)	
	RD31311508	GE-15LNPT (1/2)	
	RD31312212	GE-22LNPT (3/4)	
	RD31313520	GE-35LNPT (1"1/4)	
	RD31320804	GE-8SNPT (1/4)	
	RD31321206	GE-12SNPT (3/8)	
	RD31321608	GE-16SNPT (1/2)	
	RD31322516	GE-25SNPT (1")	
	RD31323824	GE-38SNPT (1"1/2)	

<p>GE</p> <p>Racor recto rosca NPT especial</p> 	RD31310604	GE-6LNPT (1/4)	
	RD31310806	GE-8LNPT (3/8)	
	RD31311002	GE-10LNPT (1/8)	
	RD31311008	GE-10LNPT (1/2)	
	RD31311208	GE-12LNPT (1/2)	
	RD31311812	GE-18LNPT (3/4)	
	RD31321004	GE-10SNPT (1/4)	
	RD31321208	GE-12SNPT (1/2)	

Racor Serie RD



GE

Racor recto
rosca métrica cónica



RD36100408	GE-4LLM (8X1)
RD36100610	GE-6LLM (10X1)
RD36100810	GE-8LLM (10X1)
RD36110610	GE-6LM (10X1)
RD36110812	GE-8LM (12X1,5)
RD36111014	GE-10LM (14X1,5)
RD36111216	GE-12LM (16X1,5)
RD36111518	GE-15LM (18X1,5)
RD36111822	GE-18LM (22X1,5)
RD36112226	GE-22LM (26X1,5)
RD36112833	GE-28LM (33X2)
RD36113542	GE-35LM (42X2)
RD36114248	GE-42LM (48X2)
RD36120612	GE-6SM (12X1,5)
RD36120814	GE-8SM (14X1,5)
RD36121016	GE-10SM (16X1,5)
RD36121218	GE-12SM (18X1,5)
RD36121420	GE-14SM (20X1,5)
RD36121622	GE-16SM (22X1,5)
RD36122027	GE-20SM (27X2)
RD36122533	GE-25SM (33X2)
RD36123042	GE-30SM (42X2)
RD36123848	GE-38SM (48X2)



Racor Serie RD

<p>EVGE-ED</p> <p>Nipples de salida tubular con junta llana rosca gas cilíndrica</p> 	RD41110602	EVGE-6LR (1/8)		
	RD41111004	EVGE-10LR (1/4)		
	RD41111508	EVGE-15LR (1/2)		
	RD41112212	EVGE-22LR (3/4)		
	RD41113520	EVGE-35LR (1"1/4)		
	RD41120804	EVGE-8SR (1/4)		
	RD41121206	EVGE-12SR (3/8)		
	RD41121608	EVGE-16SR (1/2)		
	RD41122516	EVGE-25SR (1")		
	RD41123824	EVGE-38SR (1"1/2)		

<p>EVGE-ED</p> <p>Nipples de salida tubular con junta llana rosca métrica</p> 	RD41110610	EVGE-6LM (10X1)		
	RD41111014	EVGE-10LM (14X1.5)		
	RD41111518	EVGE-15LM (18X1.5)		
	RD41112226	EVGE-22LM (26X1.5)		
	RD41113542	EVGE-35LM (42X2)		
	RD41110814	EVGE-8SM (14X1,5)		
	RD41 111218	EVGE-12SM (18X1,5)		
	RD41111622	EVGE-16SM (22X1.5)		
	RD41112533	EVGE-25SM (33X2)		
	RD41113848	EVGE-38SM (48X2)		



GAI Racor recto hembra rosca gas cilíndrica especial	RD30110602	GAI-6LR (1/8)	
	RD30110806	GAI-8LR (3/8)	
	RD30111004	GAI-10LR (1/4)	
	RD30111008	GAI-10LR (1/2)	
	RD31111208	GAI-12LR (1/2)	
	RD30111808	GAI-18LR (1/2)	
	RD30112816	GAI-28LR (1")	
	RD30114224	GAI-42LR (1"1/2)	
	RD30120604	GAI-6SR (1/4)	
	RD30121006	GAI-10SR (3/8)	
	RD30121408	GAI-14SR (1/2)	
	RD30122012	GAI-20SR (3/4)	
	RD30123020	GAI-30SR (1"1/4)	





GAI Racor recto hembra rosca métrica cilíndrica	RD31110610	GAI-6LM (10-100)	
	RD31111014	GAI-10LM (14-150)	
	RD31111518	GAI-15LM (18-150)	
	RD31112226	GAI-22LM (26-150)	
	RD31113542	GAI-35LM (42-200)	
	RD31120814	GAI-8SM (14-150)	
	RD31121218	GAI-12SM (18-150)	
	RD31121622	GAI-16SM (22-150)	
	RD31122533	GAI-25SM (33-200)	
	RD31123848	GAI-38SM (48-200)	





Racor Serie RD

Tipo	Código	Referencia	Acero PVP €	Inox PVP €
G Racor de unión, recto 	RD32000404	G-4LL		
	RD32000606	G-6LL		
	RD32000808	G-8LL		
	RD32001010	G-10LL		
	RD32001212	G-12LL		
	RD32010606	G-6L		
	RD32010808	G-8L		
	RD32011010	G-10L		
	RD32011212	G-12L		
	RD32011515	G-15L		
	RD32011818	G-18L		
	RD32012222	G-22L		
	RD32012828	G-28L		
	RD32013535	G-35L		
	RD32014242	G-42L		
	RD32020606	G-6S		
	RD32020808	G-8S		
	RD32021010	G-10S		
	RD21021212	G-12S		
	RD32021414	G-14S		
	RD32021616	G-16S		
	RD32022020	G-20S		
	RD32022525	G-25S		
	RD32023030	G-30S		
	RD32023838	G-38S		

Tipo	Código	Referencia	Acero PVP €	Inox PVP €
W Racor de unión en codo 	RD52000404	W-4LL		
	RD52000606	W-6LL		
	RD52000808	W-8LL		
	RD52001010	W-10LL		
	RD52001212	W-12LL		
	RD52010606	W-6L		
	RD52010808	W-8L		
	RD52011010	W-10L		
	RD52011212	W-12L		
	RD52011515	W-15L		
	RD52011818	W-18L		
	RD52012222	W-22L		
	RD52012828	W-28L		
	RD52013535	W-35L		
	RD52014242	W-42L		
	RD52020606	W-6S		
	RD52020808	W-8S		
	RD52021010	W-10S		
	RD52021212	W-12S		
	RD52021414	W-14S		
	RD52021616	W-16S		
	RD52022020	W-20S		
	RD52022525	W-25S		
	RD52023030	W-30S		
	RD52023838	W-38S		

Racor Serie RD



Tipo	Código	Referencia	Acero PVP €	Inox PVP €
GR Racor de unión, recto reducido 	RD32000604	GR-6/4LL		
	RD32000804	GR-8/4LL		
	RD32000806	GR-8/6LL		
	RD32010806	GR-8/6L		
	RD32011006	GR-10/6L		
	RD32011008	GR-10/8L		
	RD32011206	GR-12/6L		
	RD32011208	GR-12/8L		
	RD32011210	GR-12/10L		
	RD32011510	GR-15/10L		
	RD32011512	GR-15/12L		
	RD32011810	GR-18/10L		
	RD32011812	GR-18/12L		
	RD32011818	GR-18/15L		
	RD32012212	GR-22/12L		
	RD32012215	GR-22/15L		
	RD32012218	GR-22/18L		
	RD32012818	GR-28/18L		
	RD32012822	GR-28/22L		
	RD32013522	GR-35/22L		
	RD32013528	GR-35/28L		
	RD32020806	GR-8/6S		
	RD32021006	GR-10/6S		
	RD32021008	GR-10/8S		
	RD32021206	GR-12/6S		
	RD32021208	GR-12/8S		
	RD32021210	GR-12/10S		
	RD32021410	GR-14/10S		
	RD32021412	GR-14/12S		
	RD32021612	GR-16/12S		
	RD32021614	GR-16/14S		
	RD32022010	GR-20/10S		
	RD32022012	GR-20/12S		
	RD32022014	GR-20/14S		
	RD32022016	GR-20/16S		
	RD32022516	GR-25/16S		
	RD32022520	GR-25/20S		
	RD32023020	GR-30/20S		
	RD32023025	GR-30/25S		
	RD32023825	GR-38/25S		
RD32023830	GR-38/30S			



Racor Serie RD

Tipo	Código	Referencia	Acero PVP €	Inox PVP €	
SV Racor de unión pasatabiques 	RD38010606	SV-6L			
	RD38010808	SV-8L			
	RD38011010	SV-10L			
	RD38011212	SV-12L			
	RD38011515	SV-15L			
	RD38011818	SV-18L			
	RD38012222	SV-22L			
	RD38012828	SV-28L			
	RD38013535	SV-35L			
	RD38014242	SV-42L			
	RD38020606	SV-6S			
	RD38020808	SV-8S			
	RD38021010	SV-10S			
	RD38021212	SV-12S			
	RD38021414	SV-14S			
	RD38021616	SV-16S			
	RD38022020	SV-20S			
	RD38022525	SV-25S			
	RD38023030	SV-30S			
	RD38023838	SV-38S			

Tipo	Código	Referencia	Acero PVP €	Inox PVP €	
WSV Racor de unión en codo pasatabiques 	RD58010606	WSV-6L			
	RD58010808	WSV-8L			
	RD58011010	WSV-10L			
	RD58011212	WSV-12L			
	RD58011515	WSV-15L			
	RD58011818	WSV-18L			
	RD58012222	WSV-22L			
	RD58012828	WSV-28L			
	RD58013535	WSV-35L			
	RD58014242	WSV-42L			
	RD58020606	WSV-6S			
	RD58020808	WSV-8S			
	RD58021010	WSV-10S			
	RD58021212	WSV-12S			
	RD58021414	WSV-14S			
	RD58021616	WSV-16S			
	RD58022020	WSV-20S			
	RD58022525	WSV-25S			
	RD58023030	WSV-30S			
	RD58023838	WSV-38S			

Racor Serie RD





RACOR SERIE RD

Tipo	Código	Referencia	Acero PVP €	Inox PVP €	
EVW Codo orientable apretado 	RD53010606	EVW-6L			
	RD53010808	EVW-8L			
	RD53011010	EVW-10L			
	RD53011212	EVW-12L			
	RD53011515	EVW-15L			
	RD53011818	EVW-18L			
	RD53012222	EVW-22L			
	RD53012828	EVW-28L			
	RD53013535	EVW-35L			
	RD53014242	EVW-42L			
	RD53020606	EVW-6S			
	RD53020808	EVW-8S			
	RD53021010	EVW-10S			
	RD53021212	EVW-12S			
	RD53021414	EVW-14S			
	RD53021616	EVW-16S			
	RD53022525	EVW-20S			
	RD53022020	EVW-25S			
	RD53023030	EVW-30S			
	RD53023838	EVW-38S			

Tipo	Código	Referencia	Acero PVP €	Inox PVP €	
T Racor de unión en "T" 	RD72000404	T-4LL			
	RD72000606	T-6LL			
	RD72000808	T-8LL			
	RD72001010	T-10LL			
	RD72001212	T-12LL			
	RD72010606	T-6L			
	RD72010808	T-8L			
	RD72011010	T-10L			
	RD72011212	T-12L			
	RD72011515	T-15L			
	RD72011818	T-18L			
	RD72012222	T-22L			
	RD72012828	T-28L			
	RD72013535	T-35L			
	RD72014242	T-42L			
	RD72020606	T-6S			
	RD72020808	T-8S			
	RD72021010	T-10S			
	RD72021212	T-12S			
	RD72021414	T-14S			
	RD72021616	T-16S			
	RD72022020	T-20S			
	RD72022525	T-25S			
	RD72023030	T-30S			
	RD72023838	T-38S			





Tipo	Código	Referencia	Acero PVP €	Inox PVP €	
EVT "T" orientable apretado 	RD76010606	EVT-6L			
	RD76010808	EVT-8L			
	RD76011010	EVT-10L			
	RD76011212	EVT-12L			
	RD76011515	EVT-15L			
	RD76011818	EVT-18L			
	RD76012222	EVT-22L			
	RD76012828	EVT-28L			
	RD76013535	EVT-35L			
	RD76014242	EVT-42L			
	RD76020606	EVT-6S			
	RD76020808	EVT-8S			
	RD76021010	EVT-10S			
	RD76021212	EVT-12S			
	RD76021414	EVT-14S			
	RD76021616	EVT-16S			
	RD76022020	EVT-20S			
	RD76022525	EVT-25S			
	RD76023030	EVT-30S			
	RD76023838	EVT-38S			

Tipo	Código	Referencia	Acero PVP €	Inox PVP €	
EVL "L" orientable apretado 	RD75010606	EVL-6L			
	RD75010808	EVL-8L			
	RD75011010	EVL-10L			
	RD75011212	EVL-12L			
	RD75011515	EVL-15L			
	RD75011818	EVL-18L			
	RD75012222	EVL-22L			
	RD75012828	EVL-28L			
	RD75013535	EVL-35L			
	RD75014242	EVL-42L			
	RD75020606	EVL-6S			
	RD75020808	EVL-8S			
	RD75021010	EVL-10S			
	RD75021212	EVL-12S			
	RD75021414	EVL-14S			
	RD75021616	EVL-16S			
	RD75022020	EVL-20S			
	RD75022525	EVL-25S			
	RD75023030	EVL-30S			
	RD75023838	EVL-38S			





Racor Serie RD

Tipo	Código	Referencia	Acero PVP €	Inox PVP €
<p>WE Racor en codo rosca gas cónica</p> 	RD51200402	WE-4LLR (1/8)		
	RD51200602	WE-6LLR (1/8)		
	RD51200802	WE-8LLR (1/8)		
	RD51201004	WE-10LLR (1/4)		
	RD51201204	WE-12LLR (1/4)		
	RD51210602	WE-6LR (1/8)		
	RD51210804	WE-8LR (1/4)		
	RD51211004	WE-10LR (1/4)		
	RD51211206	WE-12LR (3/8)		
	RD51211508	WE-15RL (1/2)		
	RD51211808	WE-18RL (1/2)		
	RD51212212	WE-22RL (3/4)		
	RD51212816	WE-28RL (1")		
	RD51213520	WE-35RL (1"1/4)		
	RD51214224	WE-42RL (1"1/2)		
	RD51220604	WE-6SR (1/4)		
	RD51220804	WE-8SR (1/4)		
	RD51221006	WE-10SR (3/8)		
	RD51221206	WE-12SR (3/8)		
	RD51221408	WE-14SR (1/2)		
	RD51221608	WE-16SR (1/2)		
	RD51222012	WE-20SR (3/4)		
	RD51222516	WE-25SR (1")		
	RD51223020	WE-30SR (1"1/4)		
	RD51223824	WE-38SR (1"1/2)		

Tipo	Código	Referencia	Acero PVP €	Inox PVP €
<p>WE Racor en codo rosca gas cónica especial</p> 	RD51210604	WE-6LR (1/4)		
	RD51210802	WE-8LR (1/8)		
	RD51210806	WE-8LR (3/8)		
	RD51211006	WE-10LR (3/8)		
	RD51211008	WE-10LR (1/2)		
	RD51211204	WE-12LR (1/4)		
	RD51211208	WE-12LR (1/2)		
	RD51211506	WE-15LR (3/8)		
	RD51221208	WE-12SR (1/2)		
	RD51221606	WE-16SR (3/8)		
	RD51222008	WE-20SR (1/2)		



Tipo	Código	Referencia	Acero PVP €	Inox PVP €
WE Racor en codo rosca NPT 	RD51300402	WE-4LLNPT (1/8)		
	RD51300602	WE-6LLNPT (1/8)		
	RD51300802	WE-8LLNPT (1/8)		
	RD51310602	WE-6LNPT (1/8)		
	RD51310804	WE-8LNPT (1/4)		
	RD51311004	WE-10LNPT (1/4)		
	RD51311206	WE-12LNPT (3/8)		
	RD51311508	WE-15LNPT (1/2)		
	RD51311808	WE-18LNPT (1/2)		
	RD51312212	WE-22LNPT (3/4)		
	RD51312816	WE-28LNPT (1")		
	RD51313520	WE-35LNPT (1"1/4)		
	RD51314220	WE-42LNPT (1"1/2)		
	RD51320604	WE-6SNPT (1/4)		
	RD51320804	WE-8SNPT (1/4)		
	RD51321006	WE-10SNPT (3/8)		
	RD51321206	WE-12SNPT (3/8)		
	RD51321408	WE-14SNPT (1/2)		
	RD51321608	WE-16SNPT (1/2)		
	RD51322012	WE-20SNPT (3/4)		
	RD51322516	WE-25SNPT (1")		
	RD51323020	WE-30SNPT (1"1/4)		
	RD51323824	WE-38SNPT (1"1/2)		

Tipo	Código	Referencia	Acero PVP €	Inox PVP €
WE Racor en codo rosca NPT especial 	RD51310604	WE-6LNPT 1/4		
	RD51310802	WE-8LNPT 1/8		
	RD51311006	WE-10LNPT 3/8		
	RD51311204	WE-12LNPT 1/4		
	RD51311208	WE-12LNPT 1/2		

Tipo de pieza	Código	Rosca	Taladro	Precio €
WE Racor en codo rosca gas cilíndrica 	RD55212212	WE-22LR (3/4)		
	RD55212816	WE-28LR (1")		
	RD55213520	WE-35LR (1"1/4)		
	RD55214224	WE-42LR (1"1/2)		
	RD55222012	WE-20SR (3/4)		
	RD55222516	WE-25SR (1")		
	RD55223020	WE-30SR (1"1/4)		
	RD55223824	WE-38SR (1"1/2)		



Racor Serie RD

Tipo	Código	Referencia	Acero PVP €	Inox PVP €
WE Racor en codo rosca métrica cilíndrica 	RD55212226	WE-22LM (26X1,5)		
	RD55212833	WE-28LM (33X2)		
	RD55213542	WE-35LM (42X2)		
	RD55214248	WE-42LM (48X2)		
	RD55222027	WE-20SM (27X2)		
	RD55222535	WE-25SM (33X2)		
	RD55223042	WE-30SM (42X2)		
	RD55223848	WE-38SM (48X2)		

WE Racor en codo rosca métrica cónica 	RD54200408	WE-4LLM (8X1)		
	RD54200610	WE-6LLM (10X1)		
	RD54200810	WE-8LLM (10X1)		
	RD54210610	WE-6LM (10X1)		
	RD54210812	WE-8LM (12X1,5)		
	RD54211014	WE-10LM (14X1,5)		
	RD54211216	WE-12LM (16X1,5)		
	RD54211518	WE-15LM (18X1,5)		
	RD54211822	WE-18LM (22X1,5)		
	RD54220612	WE-6SM (12X1,5)		
	RD54220814	WE-8SM (14X1,5)		
	RD54221016	WE-10SM (16X1,5)		
	RD54221218	WE-12SM (18X1,5)		
	RD54221420	WE-14SM (20X1,5)		
	RD54221622	WE-16SM (22X1,5)		

Tipo	Código	Referencia	Acero PVP €	Inox PVP €
TE Racor en "T" rosca gas cónica 	RD70000402	TE-4LLR (1/8)		
	RD7000 0602	TE-6LLR (1/8)		
	RD70000802	TE-8LLR (1/8)		
	RD70001004	TE-10LLR (1/4)		
	RD70001204	TE-12LLR (1/4)		
	RD70010602	TE-6LR (1/8)		
	RD70010804	TE-8LR (1/4)		
	RD70011004	TE-10LR (1/4)		
	RD70011206	TE-12LR (3/8)		
	RD70011508	TE-15LR (1/2)		
	RD70011808	TE-18LR (1/2)		
	RD70012212	TE-22LR (3/4)		
	RD70012816	TE-28LR (1")		
	RD70013520	TE-35LR (1"1/4)		
	RD70014224	TE-42LR (1"1/2)		
	RD70020604	TE-6SR (1/4)		
	RD70020804	TE-8SR (1/4)		
	RD70021006	TE-10SR (3/8)		
	RD70021206	TE-12SR (3/8)		
	RD70021408	TE-14SR (1/2)		
	RD70021608	TE-16SR (1/2)		
	RD70022012	TE-20SR (3/4)		
	RD70022516	TE-25SR (1")		
	RD70023020	TE-30SR (1"1/4)		
	RD70023824	TE-38SR (1"1/2)		

Racor Serie RD



RACOR SERIE RD

Tipo	Código	Referencia	Acero PVP €	Inox PVP €	
<p>TE</p> <p>Racor en "T" rosca métrica cónica</p> 	RD7000408	TE-4LLM (8X1)			
	RD7000610	TE-6LLM (10X1)			
	RD7000810	TE-8LLM (10X1)			
	RD70010610	TE-6LM (10X1)			
	RD70010812	TE-8LM (12X1,5)			
	RD70011014	TE-10LM (14X1,5)			
	RD70011216	TE-12LM (16X1,5)			
	RD70011518	TE-15LM (18X1,5)			
	RD70011822	TE-18LM (22X1,5)			
	RD70020612	TE-6SM (12X1,5)			
	RD70020814	TE-8SM (14X1,5)			
	RD70021016	TE-10SM (16X1,5)			
	RD70021218	TE-12SM (18X1,5)			
	RD70021420	TE-14SM (20X1,5)			
	RD70021622	TE-16SM (22X1,5)			

Tipo	Código	Referencia	Acero PVP €	Inox PVP €	
<p>TE</p> <p>Racor en "T" rosca NPT</p> 	RD71000402	TE-4LLNPT (1/8)			
	RD71000602	TE-6LLNPT (1/8)			
	RD71000802	TE-8LLNPT (1/8)			
	RD71010602	TE-6LNPT (1/8)			
	RD71010804	TE-8LNPT (1/4)			
	RD71011004	TE-10LNPT (1/4)			
	RD71011206	TE-12LNPT (3/8)			
	RD71011508	TE-15LNPT (1/2)			
	RD71011808	TE-18LNPT (1/2)			
	RD71012212	TE-22LNPT (3/4)			
	RD71012816	TE-28LNPT (1")			
	RD71013520	TE-35LNPT (1"1/4)			
	RD71014224	TE-42LNPT (1"1/2)			
	RD71020604	TE-6SNPT (1/4)			
	RD71020804	TE-8SNPT (1/4)			
	RD71021006	TE-10SNPT (3/8)			
	RD71021206	TE-12SNPT (3/8)			
	RD71021408	TE-14SNPT (1/2)			
	RD71021608	TE-16SNPT (1/2)			
	RD71022012	TE-20SNPT (3/4)			
	RD71022516	TE-25SNPT (1")			
	RD71023020	TE-30SNPT (1"1/4)			
	RD71023820	TE-38SNPT (1"1/2)			



Racor Serie RD

Tipo	Código	Referencia	Acero PVP €	Inox PVP €
TE Racor en "T" rosca gas cilíndrica 	RD77012212	TE-22LR (3/4)		
	RD77012816	TE-28LR (1")		
	RD77013520	TE-35LR (1"1/4)		
	RD77014224	TE-42LR (1"1/2)		
	RD77022012	TE-20SR (3/4)		
	RD77022516	TE-25SR (1")		
	RD77023020	TE-30SR (1"1/4)		
	RD77023824	TE-38SR (1"1/2)		

TE Racor en "T" rosca métrica cilíndrica 	RD77012226	TE- 22LM (26X1,5)		
	RD77012833	TE- 28LM (33X2)		
	RD77013542	TE- 35LM (42X2)		
	RD77014248	TE- 42LM (48X2)		
	RD77022027	TE- 20SM (27X2)		
	RD77022533	TE- 25SM (33X2)		
	RD77023042	TE- 30SM (42X2)		
	RD77023848	TE- 38SM (48X2)		

Racor Serie RD



RACOR SERIE RD

Tipo	Código	Referencia	Acero PVP €	Inox PVP €
<p>LE</p> <p>Racor en "L" rosca gas cónica</p> 	RD 7800 04 02	LE-4LLR (1/8)		
	RD 7800 05 02	LE-5LLR (1/8)		
	RD 7800 06 02	LE-6LLR (1/8)		
	RD 7800 08 02	LE-8LLR (1/8)		
	RD 7801 06 02	LE-6LR (1/8)		
	RD 7801 08 04	LE-8LR (1/4)		
	RD 7801 10 04	LE-10LR (1/4)		
	RD 7801 12 06	LE-12LR (3/8)		
	RD 7801 15 08	LE-15LR (1/2)		
	RD 7801 18 08	LE-18LR (1/2)		
	RD 7801 22 12	LE-22LR (3/4)		
	RD 7801 28 16	LE-28LR (1")		
	RD 7801 35 20	LE-35LR (1"1/4)		
	RD 7801 42 24	LE-42LR (1"1/2)		
	RD 7802 06 04	LE-6SR (1/4)		
	RD 7802 08 04	LE-8SR (1/4)		
	RD 7802 10 06	LE-10SR (3/8)		
	RD 7802 12 06	LE-12SR (3/8)		
	RD 7802 14 08	LE-14SR (1/2)		
	RD 7802 16 08	LE-16SR (1/2)		
	RD 7802 20 12	LE-20SR (3/4)		
	RD 7802 25 16	LE-25SR (1")		
	RD 7802 30 20	LE-30SR (1"1/4)		
	RD 7802 38 24	LE-38SR (1"1/2)		

<p>LE</p> <p>Racor en "L" rosca NPT</p> 	RD 7900 04 02	LE-4LLNPT (1/8)		
	RD 7900 05 02	LE-5LLNPT (1/8)		
	RD 7900 06 02	LE-6LLNPT (1/8)		
	RD 7900 08 02	LE-8LLNPT (1/8)		
	RD 7901 06 02	LE-6LNPT (1/8)		
	RD 7901 08 04	LE-8LNPT (1/4)		
	RD 7901 10 04	LE-10LNPT (1/4)		
	RD 7901 12 06	LE-12LNPT (3/8)		
	RD 7901 15 08	LE-15LNPT (1/2)		
	RD 7901 18 08	LE-18LNPT (1/2)		
	RD 7901 22 12	LE-22LNPT (3/4)		
	RD 7901 28 16	LE-28LNPT (1")		
	RD 7901 35 20	LE-35LNPT (1"1/4)		
	RD 7901 42 24	LE-42LNPT (1"1/2)		
	RD 7902 06 04	LE-6SNPT (1/4)		
	RD 7902 08 04	LE-8SNPT (1/4)		
	RD 7902 10 06	LE-10SNPT (3/8)		
	RD 7902 12 06	LE-12SNPT (3/8)		
	RD 7902 14 08	LE-14SNPT (1/2)		
	RD 7902 16 08	LE-16SNPT (1/2)		
	RD 7902 20 12	LE-20SNPT (3/4)		
	RD 7902 25 16	LE-25SNPT (1")		
	RD 7902 30 20	LE-30SNPT (1"1/4)		
	RD 7902 38 24	LE-38SNPT (1"1/2)		



Racor Serie RD

Tipo	Código	Referencia	Acero PVP €	Inox PVP €
<p>DSVW</p> <p>Racor orientable rosca GAS cilíndrica</p> 	RD57000402	DSVW-4LLR (1/8)		
	RD57000602	DSVW-6LLR (1/8)		
	RD57000802	DSVW-8LLR (1/8)		
	RD57110602	DSVW-6LR (1/8)		
	RD57110804	DSVW-8LR (1/4)		
	RD57111004	DSVW-10LR (1/4)		
	RD57111206	DSVW-12LR (3/8)		
	RD57111508	DSVW-15LR (1/2)		
	RD57111808	DSVW-18LR (1/2)		
	RD57112212	DSVW-22LR (3/4)		
	RD57112816	DSVW-28LR (1")		
	RD57113520	DSVW-35LR (1"1/4)		
	RD57114224	DSVW-42LR (1"1/2)		
	RD57120604	DSVW-6SR (1/4)		
	RD57120804	DSVW-8SR (1/4)		
	RD57121006	DSVW-10SR (3/8)		
	RD57121206	DSVW-12SR (3/8)		
	RD57121408	DSVW-14SR (1/2)		
	RD57121608	DSVW-16SR (1/2)		
	RD57122012	DSVW-20SR (3/4)		
	RD57122516	DSVW-25SR (1")		
	RD57123020	DSVW-30SR (1"1/4)		
	RD57123824	DSVW-38SR (1"1/2)		

<p>DSVW</p> <p>Racor orientable rosca MÉTRICO cilíndrica</p> 	RD 5720 04 08	DSVW-4LLM (8X1)		
	RD 5720 06 10	DSVW-6LLM (10X1)		
	RD 5720 08 10	DSVW-8LLM (10X1)		
	RD 5721 06 10	DSVW-6LM (10X1)		
	RD 5721 08 12	DSVW-8LM (12X1,5)		
	RD 5721 10 14	DSVW-10LM (14X1,5)		
	RD 5721 12 16	DSVW-12LM (16X1,5)		
	RD 5721 15 18	DSVW-15LM (18X1,5)		
	RD 5721 18 22	DSVW-18LM (22X1,5)		
	RD 5722 06 12	DSVW-6SM (12X1,5)		
	RD 5722 08 14	DSVW-8SM (14X1,5)		
	RD 5722 10 16	DSVW-10SM (16X1,5)		
	RD 5722 12 18	DSVW-12SM (18X1,5)		
	RD 5722 14 20	DSVW-14SM (20X1,5)		
	RD 5722 16 22	DSVW-16SM (22X1,5)		
	RD 5722 20 27	DSVW-20SM (27X2)		
	RD 5722 25 33	DSVW-25SM (33X2)		
	RD 5722 30 42	DSVW-30SM (42X2)		
	RD 5722 38 48	DSVW-38SM (48X2)		

Racor Serie RD



RACOR SERIE RD

Tipo	Código	Referencia	Acero PVP €	Inox PVP €
MAV Racor hembra para manómetro 	RD 3911 06 04	MAV-6L		
	RD 3911 08 04	MAV-8L		
	RD 3911 10 04	MAV-10L		
	RD 3911 12 04	MAV-12L		
	RD 3912 06 08	MAV-6S		
	RD 3912 08 08	MAV-8S		
	RD 3912 10 08	MAV-10S		
	RD 3912 12 08	MAV-12S		

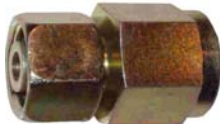
MAV-EV 	RD 3913 06 04	MAV-EV-6LR		
	RD 3913 08 04	MAV-EV-8LR		
	RD 3913 10 04	MAV-EV-10LR		
	RD 3913 12 04	MAV-EV-12LR		
	RD 3914 06 08	MAV-EV-6SR		
	RD 3914 08 08	MAV-EV-8SR		
	RD 3914 10 08	MAV-EV-10SR		
	RD 3914 12 08	MAV-EV-12SR		



Racor Serie RD

Tipo	Código	Referencia	Acero PVP €	Inox PVP €
KOR SERIE PESADA Adaptador de reducción. Apretado	RD33020806	KOR-8/6S		
	RD33021006	KOR-10/6S		
	RD33021008	KOR-10/8S		
	RD33021206	KOR-12/6S		
	RD33021208	KOR-12/8S		
	RD33021210	KOR-12/10S		
	RD33021406	KOR-14/6S		
	RD33021408	KOR-14/8S		
	RD33012410	KOR-14/10S		
	RD33021412	KOR-14/12S		
	RD33021606	KOR-16/6S		
	RD33021608	KOR-16/8S		
	RD33021610	KOR-16/10S		
	RD33021612	KOR-16/12S		
	RD33022006	KOR-20/6S		
	RD33022008	KOR-20/8S		
	RD33022010	KOR-20/10S		
	RD33022012	KOR-20/12S		
	RD33022016	KOR-20/16S		
	RD33022506	KOR-25/6S		
	RD33022508	KOR-25/8S		
	RD33022510	KOR-25/10S		
	RD33022512	KOR-25/12S		
	RD33022514	KOR-25/14S		
	RD33022516	KOR-25/16S		
	RD33022520	KOR-25/20S		
	RD33023006	KOR-30/6S		
	RD33023008	KOR-30/8S		
	RD33023010	KOR-30/10S		
	RD33023012	KOR-30/12S		
	RD33023014	KOR-30/14S		
	RD33023016	KOR-30/16S		
	RD33023020	KOR-30/20S		
	RD33023025	KOR-30/25S		
	RD33023806	KOR-38/6SL		
RD33023808	KOR-38/8S			
RD33023810	KOR-38/10S			
RD33023812	KOR-38/12S			
RD33023814	KOR-38/14S			
RD33023816	KOR-38/16S			
RD33023820	KOR-38/20S			
RD33023825	KOR-38/25S			
RD33023830	KOR-38/30S			



Racor Serie RD



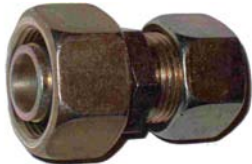

RACOR SERIE RD

Tipo	Código	Referencia	Acero PVP €	Inox PVP €
<p>KOR</p> <p>SERIE LIGERA Adaptador de reducción. Apretado</p> 	RD33010806	KOR-8/6L		
	RD33011006	KOR-10/6L		
	RD33011008	KOR-10/8L		
	RD33011206	KOR-12/6L		
	RD33011208	KOR-12/8L		
	RD33011210	KOR-12/10L		
	RD33011506	KOR-15/6L		
	RD33011508	KOR-15/8L		
	RD33011510	KOR-15/10L		
	RD33011512	KOR-15/12L		
	RD33011806	KOR-18/6L		
	RD33011808	KOR-18/8L		
	RD33011810	KOR-18/10L		
	RD33011812	KOR-18/12L		
	RD33011815	KOR-18/15L		
	RD33012206	KOR-22/6L		
	RD33012208	KOR-22/8L		
	RD33012210	KOR-22/10L		
	RD33012212	KOR-22/12L		
	RD33012215	KOR-22/15L		
	RD33012218	KOR-22/18L		
	RD33012806	KOR-28/6L		
	RD33012808	KOR-28/8L		
	RD33012810	KOR-28/10L		
	RD33012812	KOR-28/12L		
	RD33012815	KOR-28/15L		
	RD33012818	KOR-28/18L		
	RD33012822	KOR-28/22L		
	RD33013506	KOR-35/6L		
	RD33013508	KOR-35/8L		
	RD33013510	KOR-35/10L		
	RD33013512	KOR-35/12L		
	RD33013515	KOR-35/15L		
	RD33013518	KOR-35/18L		
	RD33013522	KOR-35/22L		
	RD33013528	KOR-35/28L		
	RD33014206	KOR-42/6L		
	RD33014208	KOR-42/8L		
	RD33014210	KOR-42/10L		
	RD33014212	KOR-42/12L		
	RD33014215	KOR-42/15L		
	RD33014218	KOR-42/18L		
RD33014222	KOR-42/22L			
RD33014228	KOR-42/28L			
RD33014235	KOR-42/35L			



Racor Serie RD

Tipo	Código	Referencia	Acero PVP €	Inox PVP €
<p>Tapon MACHO EXAC C/CONO</p> 	RD91010006	6L(12-150)		
	RD91010008	8L(14-150)		
	RD91010010	10L(16-150)		
	RD91010012	12L(18-150)		
	RD91010015	15L(22-150)		
	RD91010018	18L(26-150)		
	RD91010022	22L(30-200)		
	RD91010028	28L(36-200)		
	RD91010035	35L(48-200)		
	RD91010042	42L(52-200)		
	RD91020006	6S(14-150)		
	RD91020008	8S(16-150)		
	RD91020010	10S(18-150)		
	RD91020012	12S(20-150)		
	RD91020014	14S(22-150)		
	RD91020016	16S(24-150)		
	RD91020020	20S(30-200)		
	RD91020025	25S(36-200)		
	RD91020030	30S(42-200)		
	RD91020038	38S(52-200)		

<p>VKAM</p> <p>Tapon HEMBRA Cierre cono C/CJUNTA</p> 	RD93010006	VKA 6L(12-150)		
	RD93010008	VKA 8L(14-150)		
	RD93010010	VKA 10L(16-150)		
	RD93010012	VKA 12L(18-150)		
	RD93010015	VKA 15L(22-150)		
	RD93010018	VKA 18L(26-150)		
	RD93010022	VKA 22L(30-200)		
	RD93010028	VKA 28L(36-200)		
	RD93010035	VKA 35L(48-200)		
	RD93010042	VKA 42L(52-200)		
	RD93020006	VKA 6S(14-150)		
	RD93020008	VKA 8S(16-150)		
	RD93020010	VKA 10S(18-150)		
	RD93020012	VKA 12S(20-150)		
	RD93020014	VKA 14S(22-150)		
	RD93020016	VKA 16S(24-150)		
	RD93020020	VKA 20S(30-200)		
	RD93020028	VKA 25S(36-200)		
	RD93020030	VKA 30S(42-200)		
	RD93020038	VKA 38S(52-200)		



Tipo	Código	Referencia	Acero PVP €	Inox PVP €
VSTI-ED Tapon ALLEN C/CIERRE junta rosca MÉTRICA	RD92400010	VSTI (10X1M)		
	RD92400012	VSTI (12X1,5M)		
	RD92400014	VSTI (14X1,5M)		
	RD92400016	VSTI (16X1,5M)		
	RD92400018	VSTI (18X1,5M)		
	RD92400020	VSTI (20X1,5M)		
	RD92400022	VSTI (22X1,5M)		
	RD92400026	VSTI (26X1,5M)		
	RD92400027	VSTI (27X2M)		
	RD92400033	VSTI (33X2M)		
	RD92400042	VSTI (42X2M)		
	RD92400048	VSTI (48X2M)		





VSTI-ED Tapon ALLEN C/CIERRE junta rosca BSP (GAS)	RD92100002	VSTI 1/8R		
	RD92100004	VSTI 1/4R		
	RD92100006	VSTI 3/8R		
	RD92100008	VSTI 1/2R		
	RD92100012	VSTI 3/4R		
	RD92100016	VSTI 1"R		
	RD92100020	VSTI 1"1/4R		
	RD92100024	VSTI 1"1/2R		







Racor Serie RD

Tipo	Código	Referencia	Acero PVP €	Inox PVP €	
RHD 	RD43110606	RHD-6LM (10X1)			
	RD43110808	RHD-8LM (12X1,5)			
	RD43111010	RHD-10LM (14X1,5)			
	RD43111212	RHD-12LM (16X1,5)			
	RD43111515	RHD-15LM (18X1,5)			
	RD43111818	RHD-18LM (22X1,5)			
	RD43112222	RHD-22LM (26X1,5)			
	RD43112828	RHD-28LM (26X1,5)			
	RD43113535	RHD-35LM (42X2)			
	RD43114242	RHD-42LM (48X2)			
	RD43120606	RHD-6SM (12X1,5)			
	RD43120808	RHD-8SM (14X1,5)			
	RD43121010	RHD-10SM (16X1,5)			
	RD43121212	RHD-12SM (18X1,5)			
	RD43121414	RHD-14SM (20X1,5)			
	RD43121616	RHD-16SM (22X1,5)			
	RD43122020	RHD-20SM (27X2)			
	RD43122525	RHD-25SM (33X2)			
	RD43123030	RHD-30SM (42X2)			
	RD43123838	RHD-38SM (48X2)			
	RHZ M Válvulas de retención de rosca METRICA A TUBO 	RD42110610	RHZ-6LM (10X1)		
		RD42110812	RHZ-8LM (12X1,5)		
		RD42111014	RHZ-10LM (14X1,5)		
		RD42111216	RHZ-12LM (16X1,5)		
		RD42111518	RHZ-15LM (18X1,5)		
		RD42112226	RHZ-18LM (22X1,5)		
		RD42112622	RHZ-22LM (26X1,5)		
		RD42112833	RHZ-28LM (33X1)		
RD42113542		RHZ-35LM (42X2)			
RD42114248		RHZ-42LM (48X2)			
RD42120612		RHZ-6SM (12X1,5)			
RD42120814		RHZ-8SM (14X1,5)			
RD42121016		RHZ-10SM (16X1,5)			
RD42121218		RHZ-12SM (18X1,5)			
RD42121420		RHZ-14SM (20X1,5)			
RD42121622		RHZ-16SM (22X1,5)			
RD42123027		RHZ-20SM (27X2)			
RD42122533		RHZ-25SM (33X2)			
RD42123042		RHZ-30SM (42X2)			
RD42123848		RHZ-38SM (48X2)			
RHV R Válvulas de retención de TUBO A ROSCA BSP GAS 	RD44110602	RHV-6LR (1/8)			
	RD44110804	RHV-8LR (1/4)			
	RD44111004	RHV-10LR (1/4)			
	RD44111208	RHV-12LR (3/8)			
	RD44111508	RHV-15LR (1/2)			
	RD44111808	RHV-18LR (1/2)			
	RD44112212	RHV-22LR (3/4)			
	RD44112816	RHV-28LR (1")			
	RD44113520	RHV-35LR (1"1/4)			
	RD44114224	RHV-42LR (1"1/2)			
	RD44120604	RHV-6SR (1/4)			
	RD44120804	RHV-8SR (1/4)			
	RD44121006	RHV-10SR (3/8)			
	RD44121206	RHV-12SR (3/8)			
	RD44121408	RHV-14SR (1/2)			
	RD44121608	RHV-16SR (1/2)			
	RD44122012	RHV-20SR (3/4)			
	RD44122516	RHV-25SR (1")			
	RD44123020	RHV-30SR (1"1/4)			
	RD44123824	RHV-38SR (1"1/2)			



Tipo	Código	Referencia	Acero PVP €	Inox PVP €
RHV M Válvulas de retención de TUBO A ROSCA METRICA 	RD44110610	RHV-6LM (10X1)		
	RD44110812	RHV-8LM (12X1,5)		
	RD44111014	RHV-10LM (14X1,5)		
	RD44111216	RHV-12LM (16X1,5)		
	RD44111518	RHV-15LM (18X1,5)		
	RD44112226	RHV-18LM (22X1,5)		
	RD44112622	RHV-22LM (26X1,5)		
	RD44112833	RHV-28LM (33X1)		
	RD44113542	RHV-35LM (42X2)		
	RD44114248	RHV-42LM (48X2)		
	RD44120612	RHV-6SM (12X1,5)		
	RD44120814	RHV-8SM (14X1,5)		
	RD44121016	RHV-10SM (16X1,5)		
	RD44121218	RHV-12SM (18X1,5)		
	RD44121420	RHV-14SM (20X1,5)		
	RD44121622	RHV-16SM (22X1,5)		
	RD44123027	RHV-20SM (27X2)		
	RD44122533	RHV-25SM (33X2)		
	RD44123042	RHV-30SM (42X2)		
	RD44123848	RHV-38SM (48X2)		

RHZ R Válvulas de retención de ROSCA BSP GAS A TUBO DIN 	RD42110602	RHZ-6LR (1/8)		
	RD42110804	RHZ-8LR (1/4)		
	RD42111004	RHZ-10LR (1/4)		
	RD42111208	RHZ-12LR (3/8)		
	RD42111508	RHZ-15LR (1/2)		
	RD42111808	RHZ-18LR (1/2)		
	RD42112212	RHZ-22LR (3/4)		
	RD42112816	RHZ-28LR (1")		
	RD42113520	RHZ-35LR (1"1/4)		
	RD42114224	RHZ-42LR (1"1/2)		
	RD42120604	RHZ-6SR (1/4)		
	RD42120804	RHZ-8SR (1/4)		
	RD42121006	RHZ-10SR (3/8)		
	RD42121206	RHZ-12SR (3/8)		
	RD42121408	RHZ-14SR (1/2)		
	RD42121608	RHZ-16SR (1/2)		
	RD42122012	RHZ-20SR (3/4)		
	RD42122516	RHZ-25SR (1")		
	RD42123020	RHZ-30SR (1"1/4)		
	RD42123824	RHZ-38SR (1"1/2)		



Racor Serie RF

RACOR SERIE RF

Tipo de pieza	Código	Ø Brida	Pulgada	Precio €
RF3000 Semibrida S-3000 	RF3000 10 08	30.2	1/2	
	RF3000 10 12	38.1	3/4	
	RF3000 10 16	44.5	1"	
	RF3000 10 20	50.8	1"1/4	
	RF3000 10 24	60.3	1"1/2	
	RF3000 10 32	71.4	2"	
	RF3000 10 40	84.1	2"1/2	
	RF3000 10 50	101.6	3"	

RF3000 Brida entera S-3000 	RF3000 11 08	30.2	1/2	
	RF3000 11 12	38.1	3/4	
	RF3000 11 16	44.5	1"	
	RF3000 11 20	50.8	1"1/4	
	RF3000 11 24	60.3	1"1/2	
	RF3000 11 32	71.4	2"	
	RF3000 11 40	84.1	2"1/2	
	RF3000 11 50	101.6	3"	

RF3000 Cono soldar S-3000 con encaje P/Junta 	RF3000 12 08	30.2	1/2	
	RF3000 12 12	38.1	3/4	
	RF3000 12 16	44.5	1"	
	RF3000 12 20	50.8	1"1/4	
	RF3000 12 24	60.3	1"1/2	
	RF3000 12 32	71.4	2"	
	RF3000 12 40	84.1	2"1/2	
	RF3000 12 50	101.6	3"	

RF3000 Cono soldar S-3000 base plana 	RF3000 13 08	30.2	1/2	
	RF3000 13 12	38.1	3/4	
	RF3000 13 16	44.5	1"	
	RF3000 13 20	50.8	1"1/4	
	RF3000 13 24	60.3	1"1/2	
	RF3000 13 32	71.4	2"	
	RF3000 13 40	84.1	2"1/2	
	RF3000 13 50	101.6	3"	

RF3000 Brida monobloc S-3000 rosca gas con encaje P/Junta 	RF3000 14 08	30.2	1/2	
	RF3000 14 12	38.1	3/4	
	RF3000 14 16	44.5	1"	
	RF3000 14 20	50.8	1"1/4	
	RF3000 14 24	60.3	1"1/2	
	RF3000 14 32	71.4	2"	
	RF3000 14 40	84.1	2"1/2	
	RF3000 14 50	101.6	3"	

RF3000 Brida monobloc S-3000 rosca gas base plana 	RF3000 15 08	30.2	1/2	
	RF3000 15 12	38.1	3/4	
	RF3000 15 16	44.5	1"	
	RF3000 15 20	50.8	1"1/4	
	RF3000 15 24	60.3	1"1/2	
	RF3000 15 32	71.4	2"	
	RF3000 15 40	84.1	2"1/2	
	RF3000 15 50	101.6	3"	





Tipo de pieza	Código	Ø Brida	Pulgada	Precio €
RF3000 Brida monobloc soldar con encaje P/Junta 	RF3000 16 08	30.2	1/2	
	RF3000 16 12	35.1	3/4	
	RF3000 16 16	44.5	1"	
	RF3000 16 20	50.8	1"1/4	
	RF3000 16 24	60.3	1"1/2	
	RF3000 16 32	71.4	2"	
	RF3000 16 40	84.1	2"1/2	
	RF3000 16 50	101.6	3"	

RF3000 Brida monobloc soldar base plana 	RF3000 17 08	30.2	1/2	
	RF3000 17 12	35.1	3/4	
	RF3000 17 16	44.5	1"	
	RF3000 17 20	50.8	1"1/4	
	RF3000 17 24	60.3	1"1/2	
	RF3000 17 32	71.4	2"	
	RF3000 17 40	84.1	2"1/2	
	RF3000 17 50	101.6	3"	

RF3000 Tapón con encaje P/Junta 	RF3000 18 08	30.2	1/2	
	RF3000 18 12	35.1	3/4	
	RF3000 18 16	44.5	1"	
	RF3000 18 20	50.8	1"1/4	
	RF3000 18 24	60.3	1"1/2	
	RF3000 18 32	71.4	2"	
	RF3000 18 40	84.1	2"1/2	
	RF3000 18 50	101.6	3"	

RF3000 TAPÓN base plana 	RF3000 19 08	30.2	1/2	
	RF3000 19 12	35.1	3/4	
	RF3000 19 16	44.5	1"	
	RF3000 19 20	50.8	1"1/4	
	RF3000 19 24	60.3	1"1/2	
	RF3000 19 32	71.4	2"	
	RF3000 19 40	84.1	2"1/2	
	RF3000 19 50	101.6	3"	

RF3000 Codo 90° roscado con encaje para junta 	RF3000 20 08	30.2	1/2	
	RF3000 20 12	35.1	3/4	
	RF3000 20 16	44.5	1"	
	RF3000 20 20	50.8	1"1/4	
	RF3000 20 24	60.3	1"1/2	
	RF3000 20 32	71.4	2"	

RF3000 Codo 90° soldar con encaje para junta 	RF3000 21 08	30.2	1/2	
	RF3000 21 12	35.1	3/4	
	RF3000 21 16	44.5	1"	
	RF3000 21 20	50.8	1"1/4	
	RF3000 21 24	60.3	1"1/2	
	RF3000 21 32	71.4	2"	





Racor Serie RF

RACOR SERIE RF

Tipo de pieza	Código	Ø Brida	Pulgada	Precio €
RF6000 Semibrida S-6000 	RF6000 10 08	31.8	1/2	
	RF6000 10 12	41.3	3/4	
	RF6000 10 16	47.6	1"	
	RF6000 10 20	54.0	1"1/4	
	RF6000 10 24	63.5	1"1/2	
	RF6000 10 32	79.4	2"	

RF6000 Brida entera S-6000 	RF6000 11 08	31.8	1/2	
	RF6000 11 12	41.3	3/4	
	RF6000 11 16	47.6	1"	
	RF6000 11 20	54.0	1"1/4	
	RF6000 11 24	63.5	1"1/2	
	RF6000 11 32	79.4	2"	

RF6000 Cono soldar S-6000 con encaje para junta 	RF6000 12 08	31.8	1/2	
	RF6000 12 12	41.3	3/4	
	RF6000 12 16	47.6	1"	
	RF6000 12 20	54.0	1"1/4	
	RF6000 12 24	63.5	1"1/2	
	RF6000 12 32	79.4	2"	

RF6000 Cono soldar S-6000 base plana 	RF6000 13 08	31.8	1/2	
	RF6000 13 12	41.3	3/4	
	RF6000 13 16	47.6	1"	
	RF6000 13 20	54.0	1"1/4	
	RF6000 13 24	63.5	1"1/2	
	RF6000 13 32	79.4	2"	

RF6000 Brida monobloc S-6000 rosca gas con encaje para junta 	RF6000 14 08	31.8	1/2	
	RF6000 14 12	41.3	3/4	
	RF6000 14 16	47.6	1"	
	RF6000 14 20	54.0	1"1/4	
	RF6000 14 24	63.5	1"1/2	
	RF6000 14 32	79.4	2"	

RF6000 Brida monobloc S-6000 rosca gas base plana 	RF6000 15 08	31.8	1/2	
	RF6000 15 12	41.3	3/4	
	RF6000 15 16	47.6	1"	
	RF6000 15 20	54.0	1"1/4	
	RF6000 15 24	63.5	1"1/2	
	RF6000 15 32	79.4	2"	





Tipo de pieza	Código	Ø Brida	Pulgada	Precio €
RF6000 Brida monobloc soldar con encaje para juntas 	RF6000 16 08	31.8	1/2	
	RF6000 16 12	41.3	3/4	
	RF6000 16 16	47.6	1"	
	RF6000 16 20	54.0	1"1/4	
	RF6000 16 24	63.5	1"1/2	
	RF6000 16 32	79.4	2"	

RF6000 Brida monobloc soldar base plana 	RF6000 17 08	31.8	1/2	
	RF6000 17 12	41.3	3/4	
	RF6000 17 16	47.6	1"	
	RF6000 17 20	54.0	1"1/4	
	RF6000 17 24	63.5	1"1/2	
	RF6000 17 32	79.4	2"	

RF6000 Tapón con encaje para junta 	RF6000 18 08	31.8	1/2	
	RF6000 18 12	41.3	3/4	
	RF6000 18 16	47.6	1"	
	RF6000 18 20	54.0	1"1/4	
	RF6000 18 24	63.5	1"1/2	
	RF6000 18 32	79.4	2"	

RF6000 Tapón base plana 	RF6000 19 08	31.8	1/2	
	RF6000 19 12	41.3	3/4	
	RF6000 19 16	47.6	1"	
	RF6000 19 20	54.0	1"1/4	
	RF6000 19 24	63.5	1"1/2	
	RF6000 19 32	79.4	2"	

RF6000 Brida monobloc 90° roscada con encaje para junta 	RF6000 20 08	31.8	1/2	
	RF6000 20 12	41.3	3/4	
	RF6000 20 16	47.6	1"	
	RF6000 20 20	54.0	1"1/4	
	RF6000 20 24	63.5	1"1/2	
	RF6000 20 32	79.4	2"	

RF6000 Brida monobloc 90° soldar con encaje para junta 	RF6000 21 08	31.8	1/2	
	RF6000 21 12	41.3	3/4	
	RF6000 21 16	47.6	1"	
	RF6000 21 20	54.0	1"1/4	
	RF6000 21 24	63.5	1"1/2	
	RF6000 21 32	79.4	2"	